

 LaboPrint

EXPO

Best fairs way!



Exhibition stands

Promo stands

Suspended systems

Types of stands

Need a non-standard arrangement?

Send us a message!

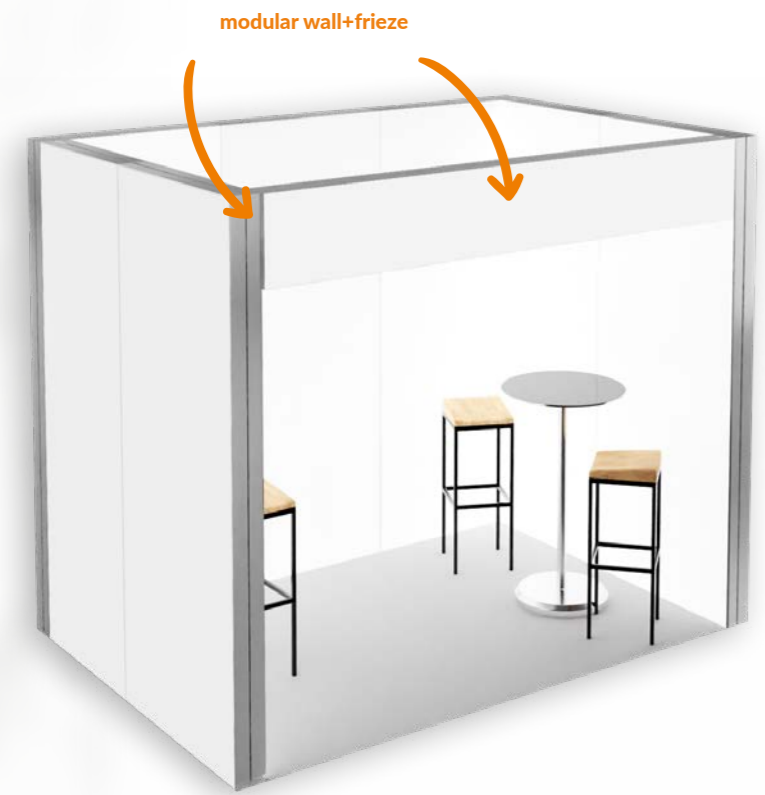

Open from two sides (L-SHAPE)



Open from one side (U-SHAPE)



Open from three sides (SEMI ISLAND)



Open from all sides (ISLAND)

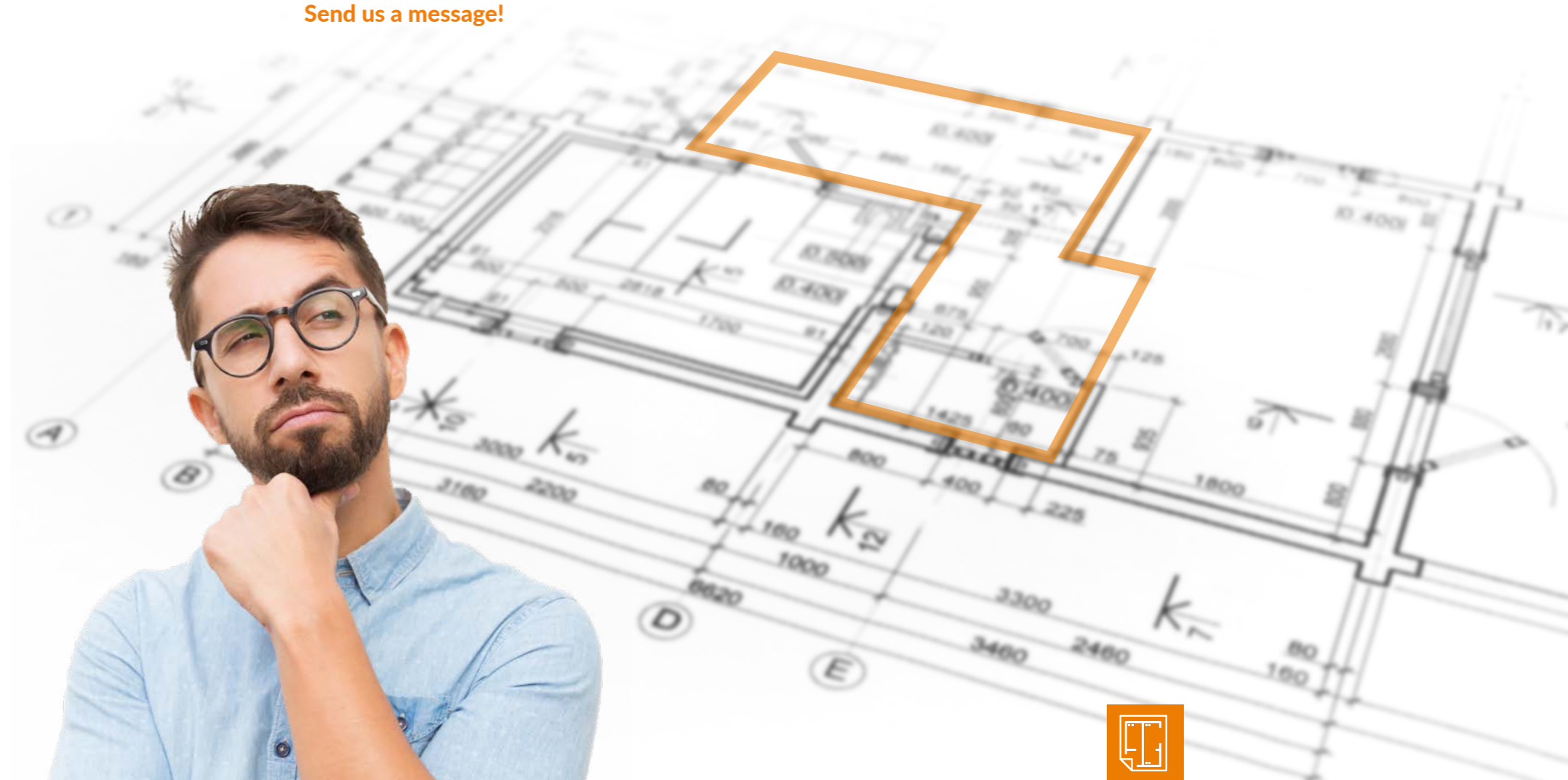

CUSTOMIZED STANDS.
Can't find a solution that meets your needs?

Send us a message!



LEGEND



PROMO STAND

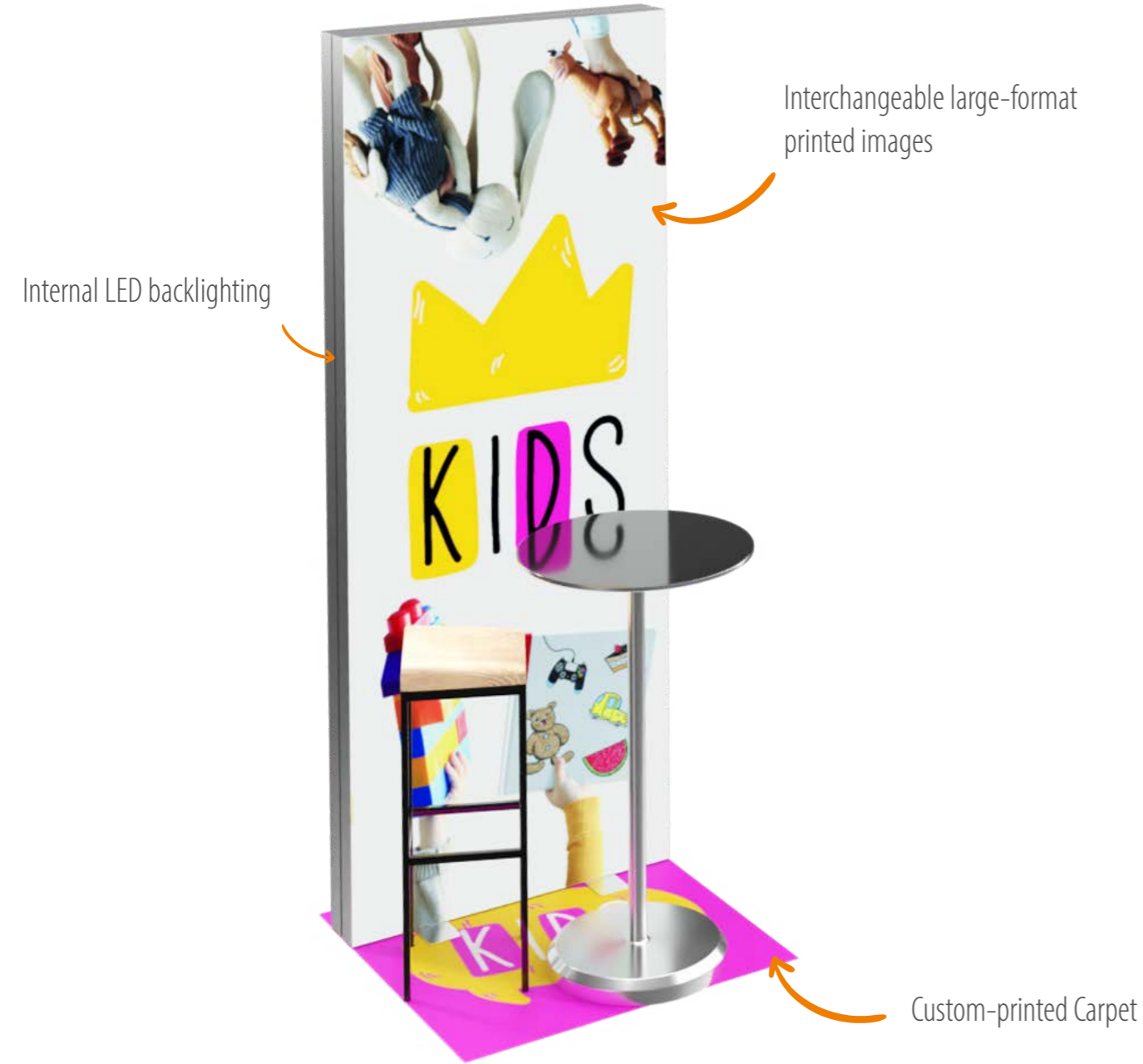

1x1 SEMI ISLAND



-  **Wall layout SEMI ISLAND**
-  **Easy Transportation**
-  **Quick installation**

The 1x1 SEMI ISLAND display stand is made of aluminium profiles for DIY assembly and carpeting with the print of your choice. Thanks to their small size, the packed elements of the stand will fit in your car. This is an excellent solution for all kinds of promotional or testing sessions in shopping centres. Comes with all elements required for assembly and an instruction manual.



Information

Promo Stand [cm]
100x100x250
Total weight [kg]
13



Details

Package dimensions [cm]
1x[255x20x15] + 1x[105x25x25]



Non-equipped stand

modular wall	1pcs
interchangeable fabric with print	1pcs
fitted carpet with print	1pcs

413 GBP



Additional equipment

Ask your advisor about tables, counters, chairs, flyer displays, extension cords or additional lighting. We also offer a range of accessories - advertising cups, flags, rollups, stands, displays and much more.

Write to us - we are at your service!

PROMO STAND

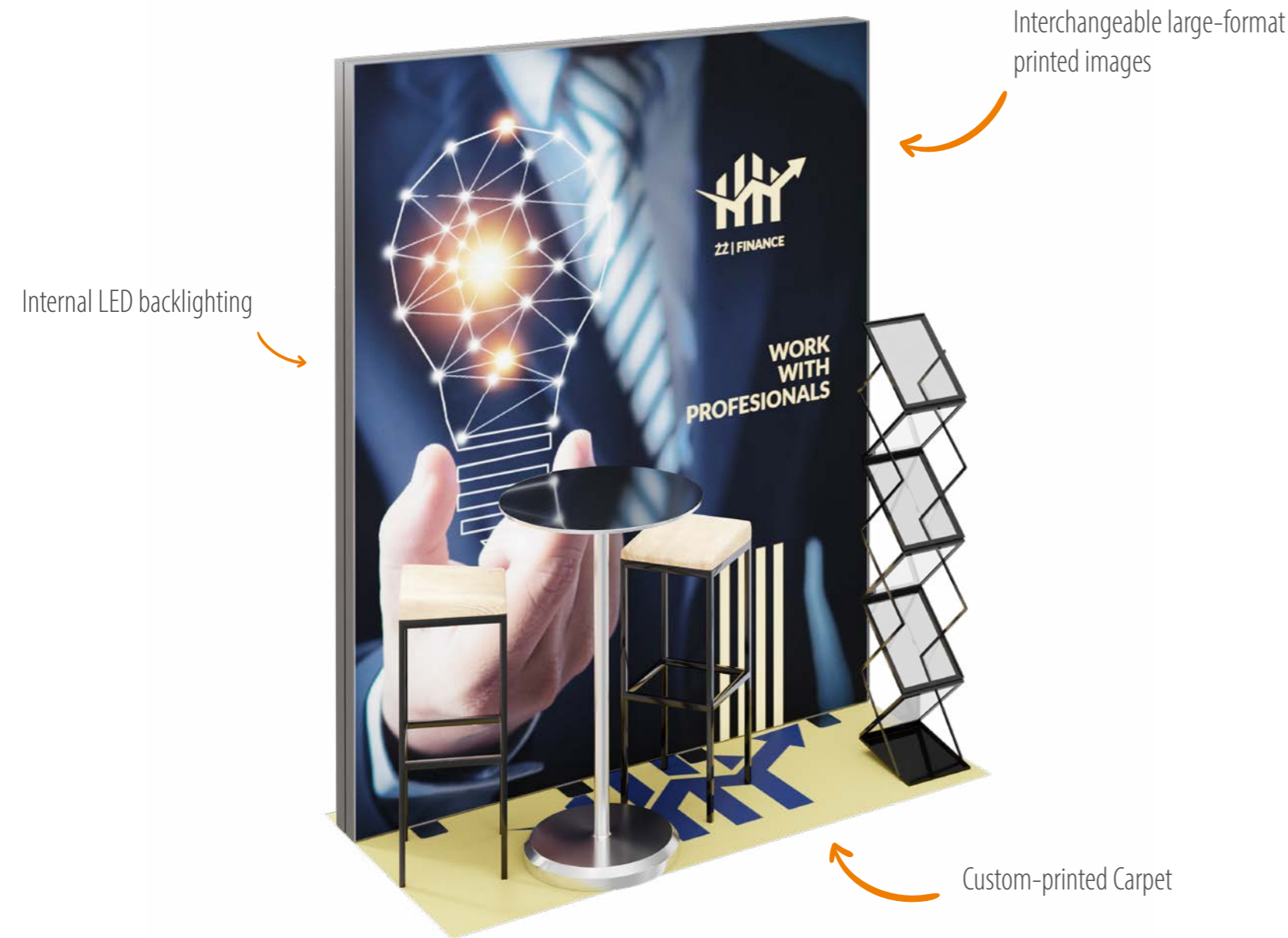

1x2 SEMI ISLAND

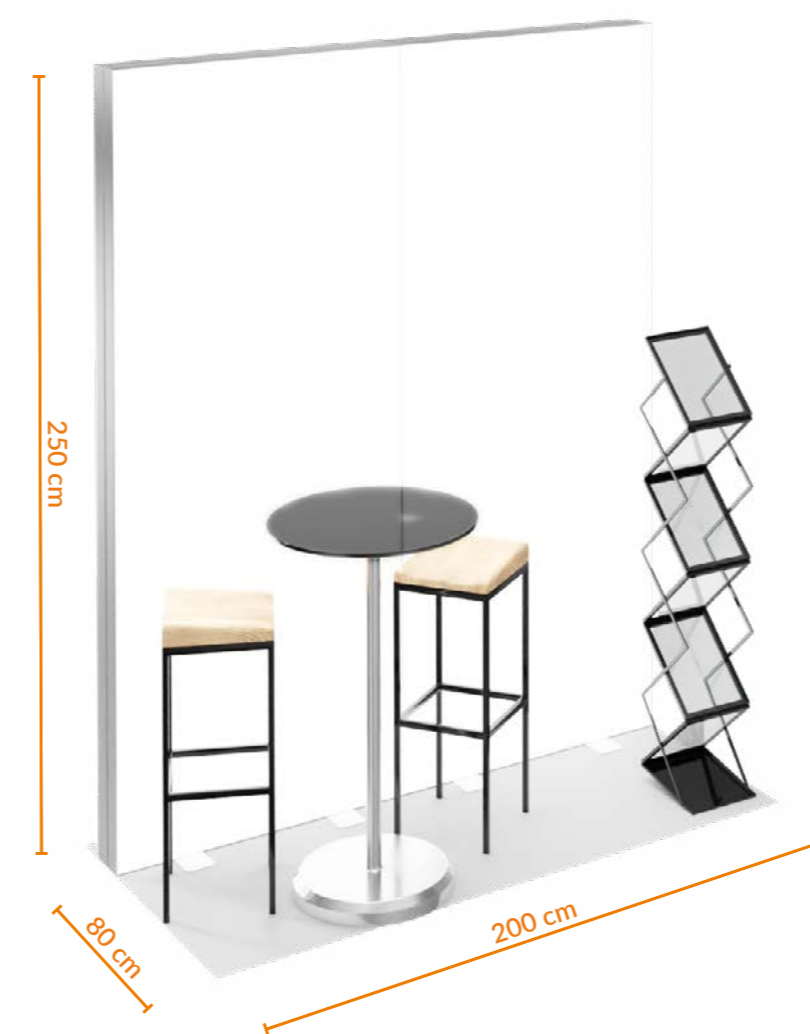

-  **Wall layout SEMI ISLAND**
-  **Easy Transportation**
-  **Quick installation**

The 1x2 SEMI ISLAND display stand is made of aluminium profiles for DIY assembly and carpeting with the print of your choice. The stand is small and easy to assemble. Will hold two chairs, a table, and a flyer holder. Comes with all elements required for assembly and an instruction manual.

Information

Promo Stand [cm]
100x200x250
Total weight [kg]
26



Details
Package dimensions [cm]
2x[255x20x15] + 1x[105x25x25]

Non-equipped stand

modular wall	2pcs
interchangeable fabric with print	1pcs
fitted carpet with print	1pcs

 **825 GBP**

Additional equipment

Additional equipment

Ask your advisor about tables, counters, chairs, flyer displays, extension cords or additional lighting. We also offer a range of accessories - advertising cups, flags, rollups, stands, displays and much more.

Write to us - we are at your service!

PROMO STAND

Interchangeable large-format printed images

Internal LED backlighting



Custom-printed Carpet

1x3 SEMI ISLAND

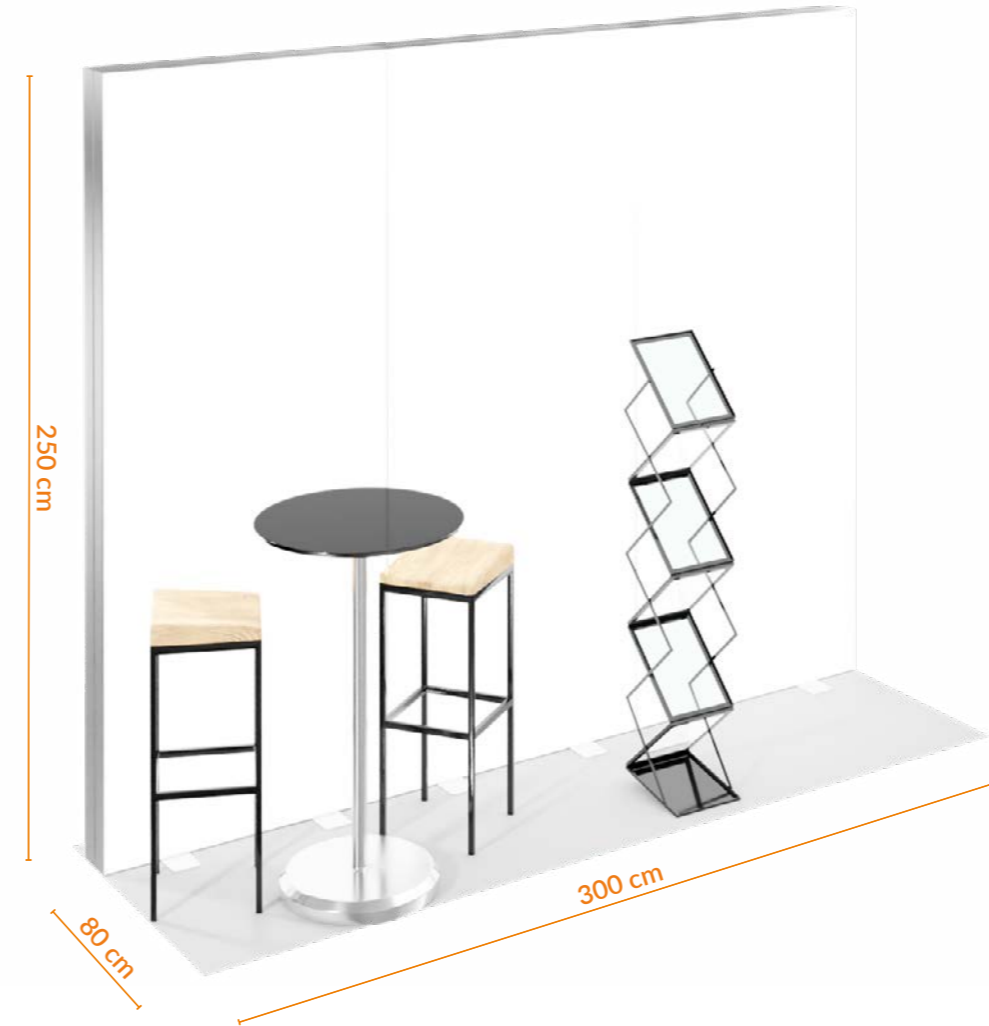

-  **Wall layout SEMI ISLAND**
-  **Easy Transportation**
-  **Quick installation**

The 1x3 SEMI ISLAND display stand is made of aluminium profiles for DIY assembly and carpeting with the print of your choice. The 3 x 2,5 m backlit wall supports large graphics display. Thanks to their small size, the packed elements of the stand will fit in your car. Comes with all elements required for assembly and an instruction manual.



Information

Promo Stand [cm]
100x300x250
Total weight [kg]
39



Details

Package dimensions [cm]
3x[255x20x15] + 1x[105x25x25]



Non-equipped stand

modular wall	3pcs
interchangeable fabric with print	1pcs
fitted carpet with print	1pcs

 **1 238 GBP**



Additional equipment

Ask your advisor about tables, counters, chairs, flyer displays, extension cords or additional lighting. We also offer a range of accessories - advertising cups, flags, rollups, stands, displays and much more.

Write to us - we are at your service!

PROMO STAND

Interchangeable large-format printed images

Internal LED backlighting



Custom-printed Carpet

1x4 SEMI ISLAND



-  **Wall layout SEMI ISLAND**
-  **Easy Transportation**
-  **Quick installation**

The 1x4 SEMI ISLAND display stand is made of a light aluminium structure for DIY assembly and carpeting with the print of your choice. The almost four square metres make it possible to arrange your equipment with freedom and arrange two conversation spaces. Thanks to their small size, the packed elements of the stand will fit in your car. Comes with all elements required for assembly and an instruction manual.

Information

Promo Stand [cm]
100x400x250
Total weight [kg]
52



Details
Package dimensions [cm]
4x[255x20x15] + 1x[105x25x25]

Non-equipped stand

modular wall	4pcs
interchangeable fabric with print	1pcs
fitted carpet with print	1pcs

1 640 GBP

Additional equipment

Ask your advisor about tables, counters, chairs, flyer displays, extension cords or additional lighting. We also offer a range of accessories - advertising cups, flags, rollups, stands, displays and much more.

Write to us - we are at your service!



Application:

- Islands in the galleries
- Business conferences
- Promotions in supermarkets
- Trade fair stands



PROMO STAND







Interchangeable large-format printed images

Internal LED backlighting

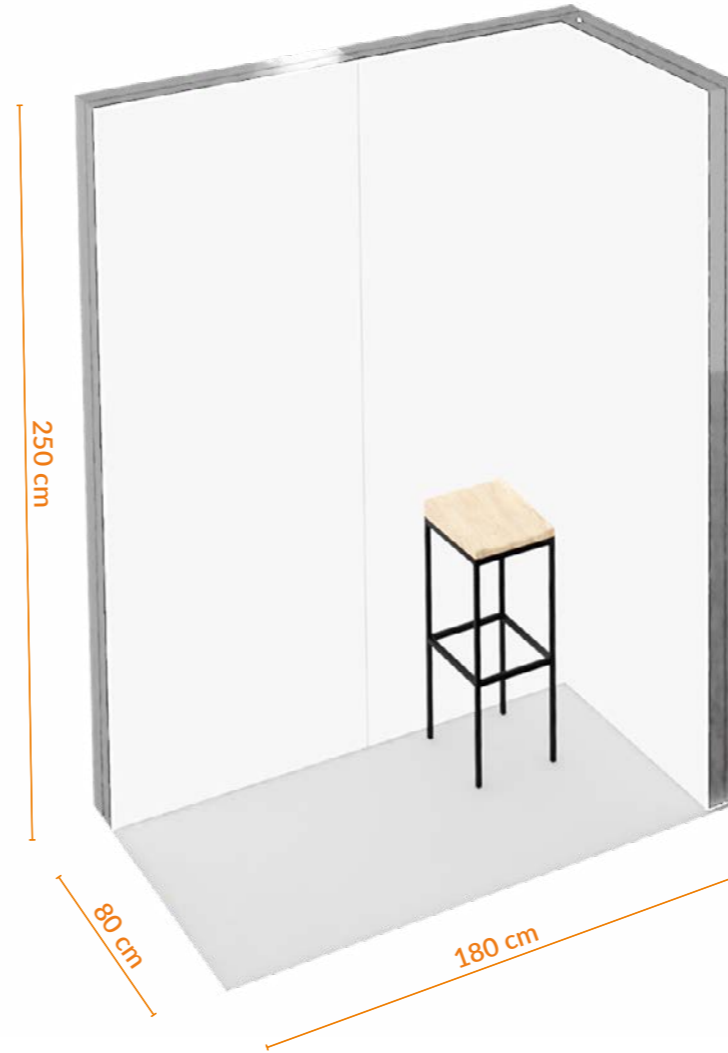
Custom-printed Carpet

2x1 L-SHAPE ZEN



-  **Wall layout L-SHAPE**
-  **Easy Transportation**
-  **Quick installation**

The 2x1 L-SHAPE ZEN display stand is made of aluminium profiles for DIY assembly and carpeting with the print of your choice. The L-shaped frames compose two partitions with backlit graphics. The structure is perfect as a mini island in shopping centres or for promotional purposes. Thanks to their small size, the packed elements of the stand will fit in your car. Comes with all elements required for assembly and an instruction manual.



Information

Promo Stand [cm]
200x100x250
Total weight [kg]
38



Details

Package dimensions [cm]
3x[255x20x15] + 1x[105x25x25]



Non-equipped stand

modular wall	3pcs
interchangeable fabric with print	2pcs
fitted carpet with print	1pcs

1 234 GBP



Additional equipment

Ask your advisor about tables, counters, chairs, flyer displays, extension cords or additional lighting. We also offer a range of accessories - advertising cups, flags, rollups, stands, displays and much more.



Write to us - we are at your service!

PROMO STAND

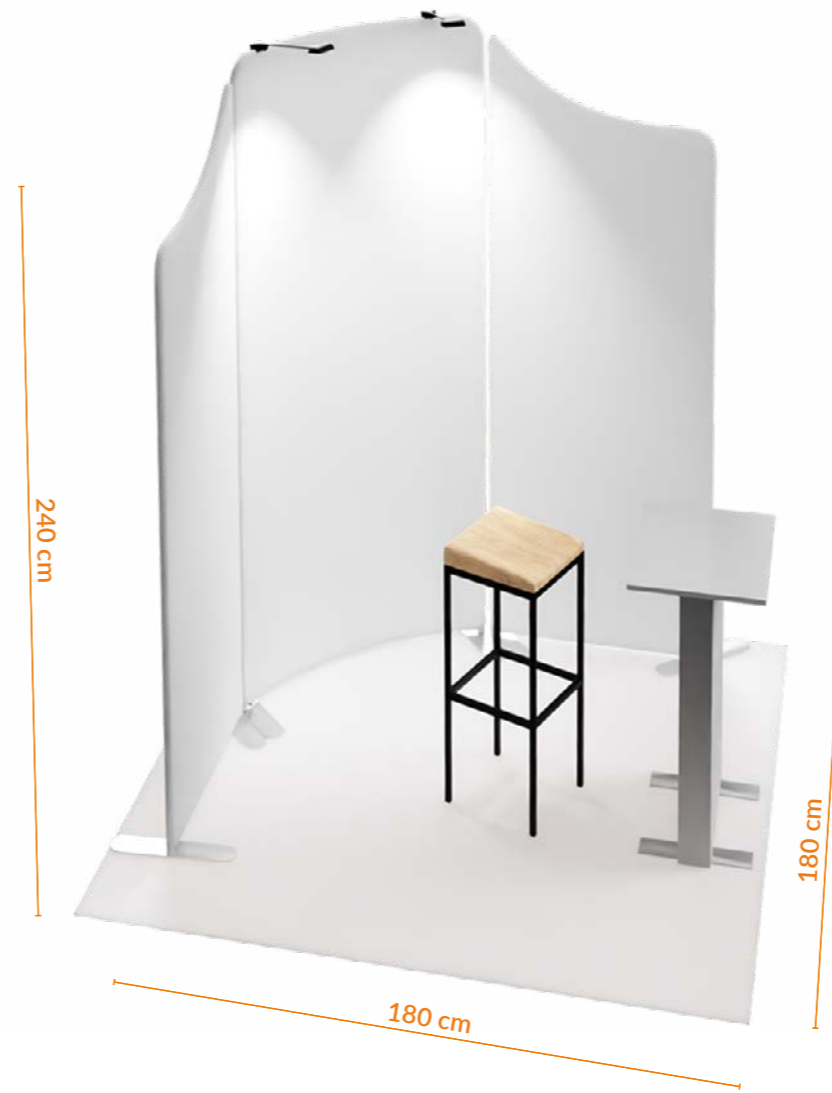

2x2 L-SHAPE



-  **Wall layout L-SHAPE**
-  **Easy Transportation**
-  **Quick installation**

The 2x2 L-SHAPE display stand is made of a light aluminium structure, which is assembled with strong magnets. Comes with carpeting with the print of your choice. The structure is foldable and fits in the dedicated bag for much easier transport. Comes with all elements required for assembly and an instruction manual.



Information

Promo Stand [cm]
200x200x240
Total weight [kg]
29



Details

Package dimensions [cm]
3x[25x103x13] + 1x[105x25x25]



Non-equipped stand

modular wall	3pcs
interchangeable fabric with print	3pcs
fitted carpet with print	1pcs

930 GBP



Additional equipment

Ask your advisor about tables, counters, chairs, flyer displays, extension cords or additional lighting. We also offer a range of accessories - advertising cups, flags, rollups, stands, displays and much more.

Write to us - we are at your service!

PROMO STAND



2x2 SEMI ISLAND

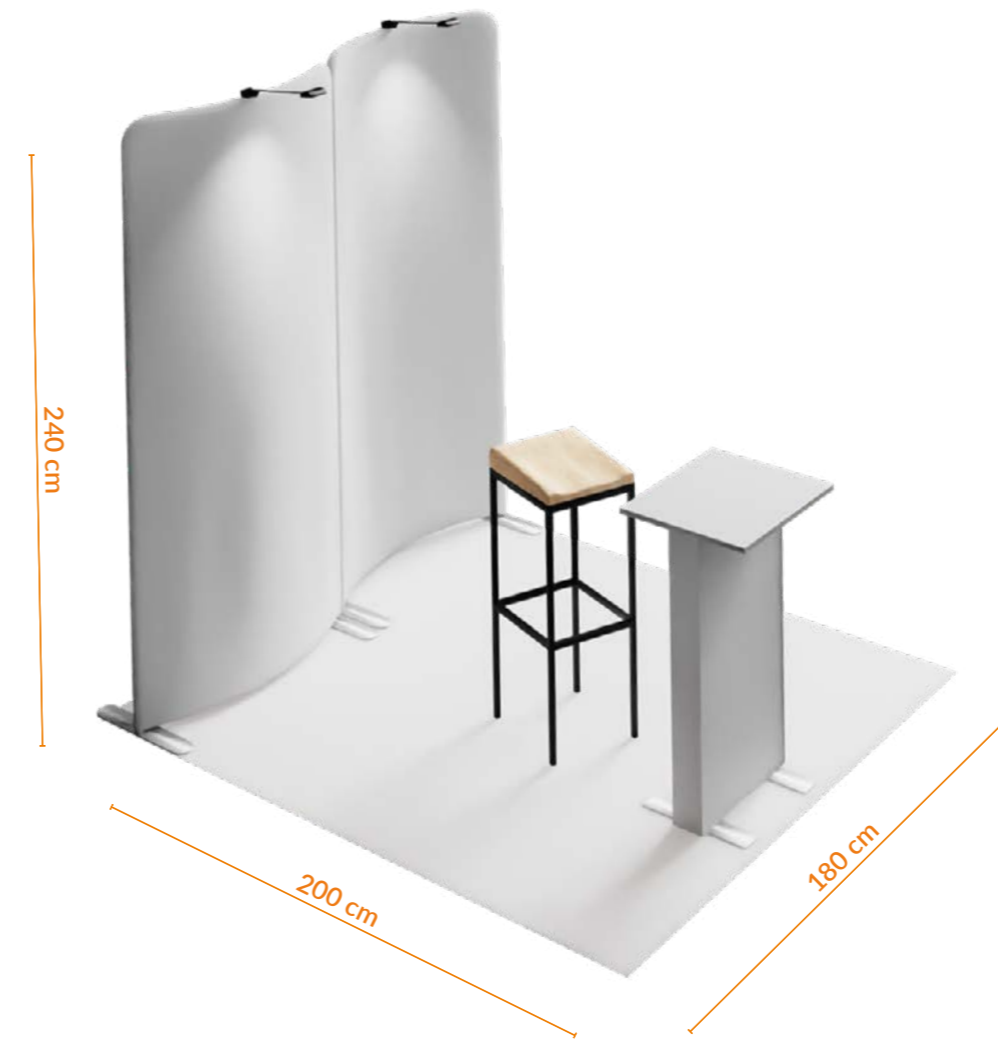

- Wall layout SEMI ISLAND**
- Easy Transportation**
- Quick installation**

The 2x2 SEMI ISLAND display stand is made of a light aluminium structure, which is assembled with strong magnets. Comes with carpeting with the print of your choice. The two stable backlit walls are perfect to display your graphics. The structure is foldable and fits in the dedicated bag for much easier transport. Comes with all elements required for assembly and an instruction manual.



Information

Promo Stand [cm]
200x200x240
Total weight [kg]
20



Details

Package dimensions [cm]
2x[25x103x13] + 1x[105x25x25]



Non-equipped stand

modular wall	2pcs
interchangeable fabric with print	2pcs
fitted carpet with print	1pcs

660 GBP



Additional equipment

Ask your advisor about tables, counters, chairs, flyer displays, extension cords or additional lighting. We also offer a range of accessories - advertising cups, flags, rollups, stands, displays and much more.

Write to us - we are at your service!

PROMO STAND

Interchangeable large-format printed images



Internal LED backlighting

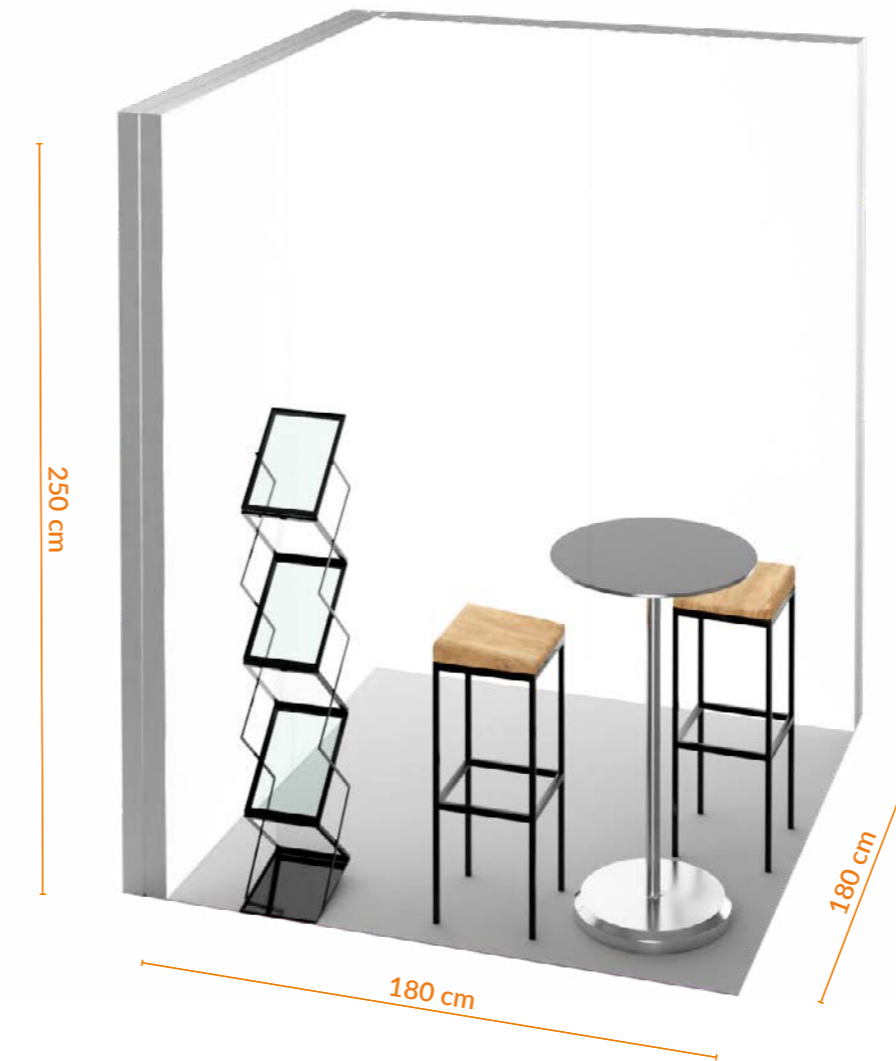

Custom-printed Carpet

2x2 L-SHAPE ZEN



-  **Wall layout L-SHAPE**
-  **Easy Transportation**
-  **Quick installation**

The 2x2 L-SHAPE ZEN display stand is made of aluminium profiles for DIY assembly and carpeting with the print of your choice. The two backlit L-shaped partitions will create comfortable space to talk with your clients. Thanks to their small size, the packed elements of the stand will fit in your car. Comes with all elements required for assembly and an instruction manual.

Information

Promo Stand [cm]
200x200x250
Total weight [kg]
52



Details

Package dimensions [cm]
4x[255x20x15] + 1x[105x25x25]

Non-equipped stand

modular wall	4pcs
interchangeable fabric with print	2pcs
fitted carpet with print	1pcs

1 650 GBP

Additional equipment

Additional equipment

Ask your advisor about tables, counters, chairs, flyer displays, extension cords or additional lighting. We also offer a range of accessories - advertising cups, flags, rollups, stands, displays and much more.

Write to us - we are at your service!

PROMO STAND



3x1 U-SHAPE ZEN

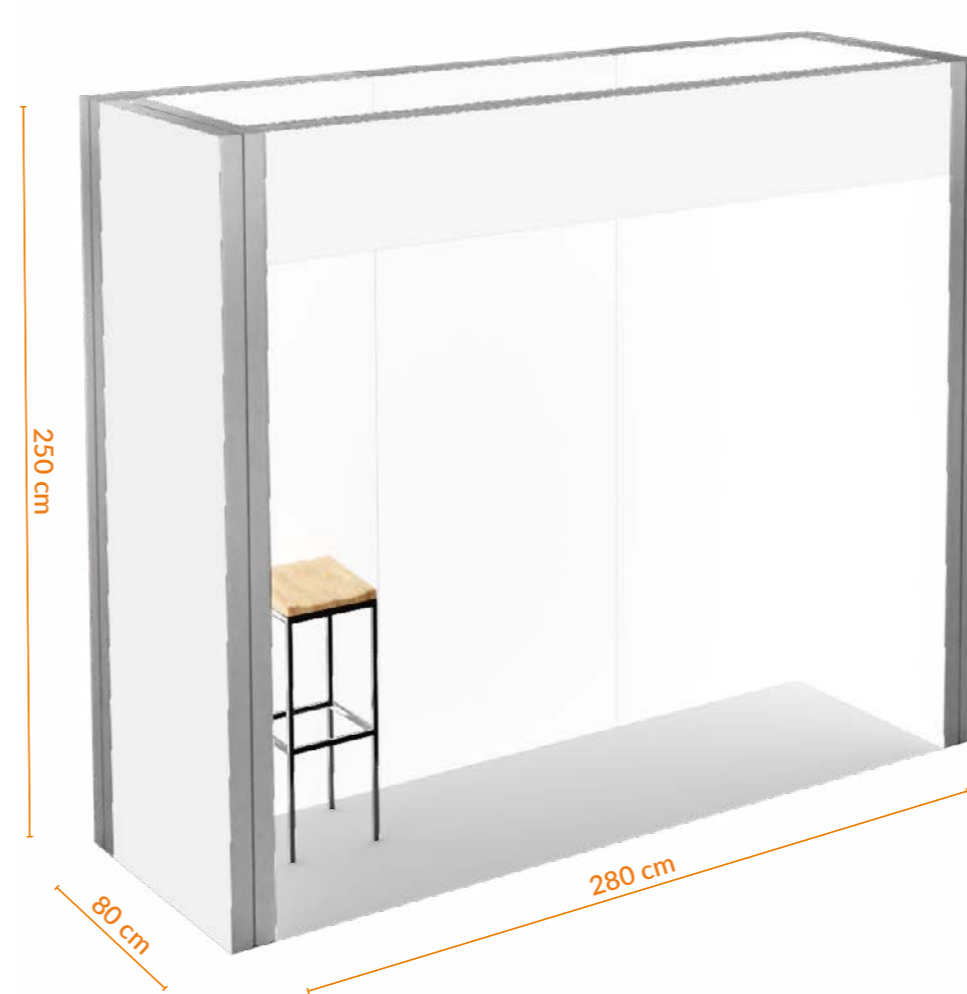

- Wall layout U-SHAPE
- Quick installation

The 3X1 U-SHAPE ZEN display stand is made of aluminium profiles for DIY assembly and carpeting with the print of your choice. This is an excellent choice for small exhibition or promotional spaces. The overhead section of the structure provides additional space for display of graphics. Thanks to their small size, the packed elements of the stand are easy to transport. Comes with all elements required for assembly and an instruction manual.

Information

Promo Stand [cm]
300x100x250
Total weight [kg]
87



Details
Package dimensions [cm]
5x[255x20x15] + 1x[105x25x25]

Non-equipped stand

modular wall+frieze	5+1pcs
interchangeable fabric with print	4pcs
fitted carpet with print	1pcs

2 406 GBP

Additional equipment

Ask your advisor about tables, counters, chairs, flyer displays, extension cords or additional lighting. We also offer a range of accessories - advertising cups, flags, rollups, stands, displays and much more.

Write to us - we are at your service!



Application:

- Islands in the galleries
- Business conferences
- Promotions in supermarkets
- Trade fair stands

EXHIBITION STAND

Interchangeable large-format printed images



LED lighting

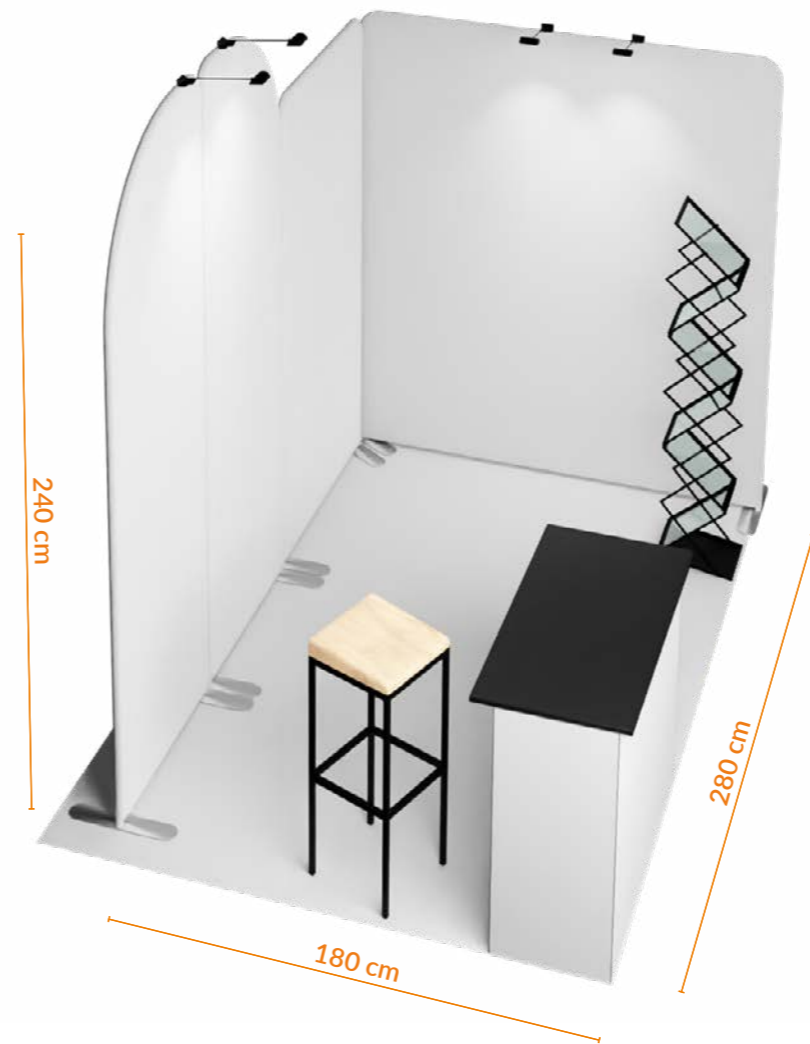

Custom-printed Carpet

3x2 L-SHAPE



-  **Wall layout L-SHAPE**
-  **Easy Transportation**
-  **Quick installation**

The 3x2 L-SHAPE exhibition stand is made of a light aluminium structure, which is assembled with strong magnets. Comes with carpeting with the print of your choice. The irregular shapes of the backlit frames allow for creative graphics designs. The structure is foldable and fits in the dedicated bags for much easier transport. Comes with all elements required for assembly and an instruction manual.

Information



Exhibition Stand [cm]
300x200x240
Total weight [kg]
49

Details

Package dimensions [cm]
4x[25x103x13] + 1x[105x25x25]

Non-equipped stand

modular wall	4pcs
interchangeable fabric with print	4pcs
fitted carpet with print	1pcs

1 508 GBP

Additional equipment

Ask your advisor about tables, counters, chairs, flyer displays, extension cords or additional lighting. We also offer a range of accessories - advertising cups, flags, rollups, stands, displays and much more.

Write to us - we are at your service!

EXHIBITION STAND



3x2 L-SHAPE A

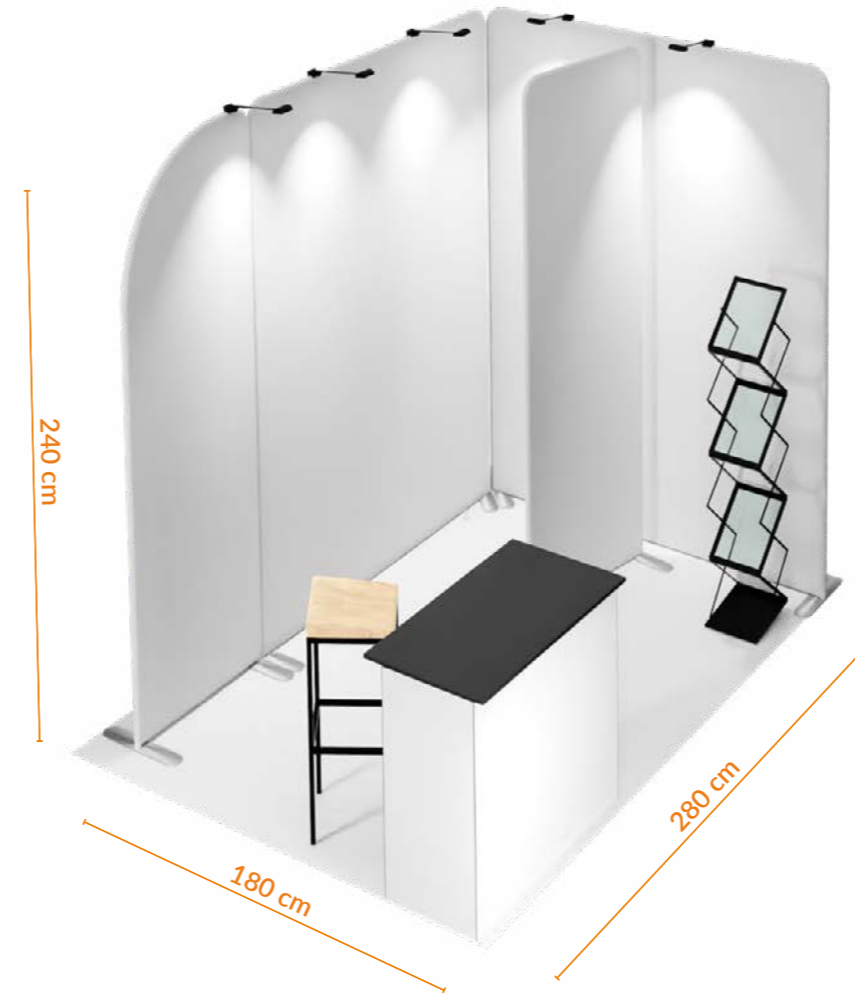

Information

Exhibition Stand [cm]
300x200x240
Total weight [kg]
44



Details

Package dimensions [cm]
5x[25x103x13] + 1x[105x25x25]



Non-equipped stand

modular wall	5pcs
interchangeable fabric with print	5pcs
fitted carpet with print	1pcs

1 721 GBP



Additional equipment

Ask your advisor about tables, counters, chairs, flyer displays, extension cords or additional lighting. We also offer a range of accessories - advertising cups, flags, rollups, stands, displays and much more.

Write to us - we are at your service!

- Wall layout L-SHAPE**
- Easy Transportation**
- Quick installation**

The 3x2 L-SHAPE A exhibition stand is made of a light aluminium structure, which is assembled with strong magnets. Comes with carpeting with the print of your choice. The stand has the same area, but a different shape than the traditional "L". The additional partition will form a small back section. The structure is foldable and fits in the dedicated bags for much easier transport. Comes with all elements required for assembly and an instruction manual.

EXHIBITION STAND



3x2 U-SHAPE A

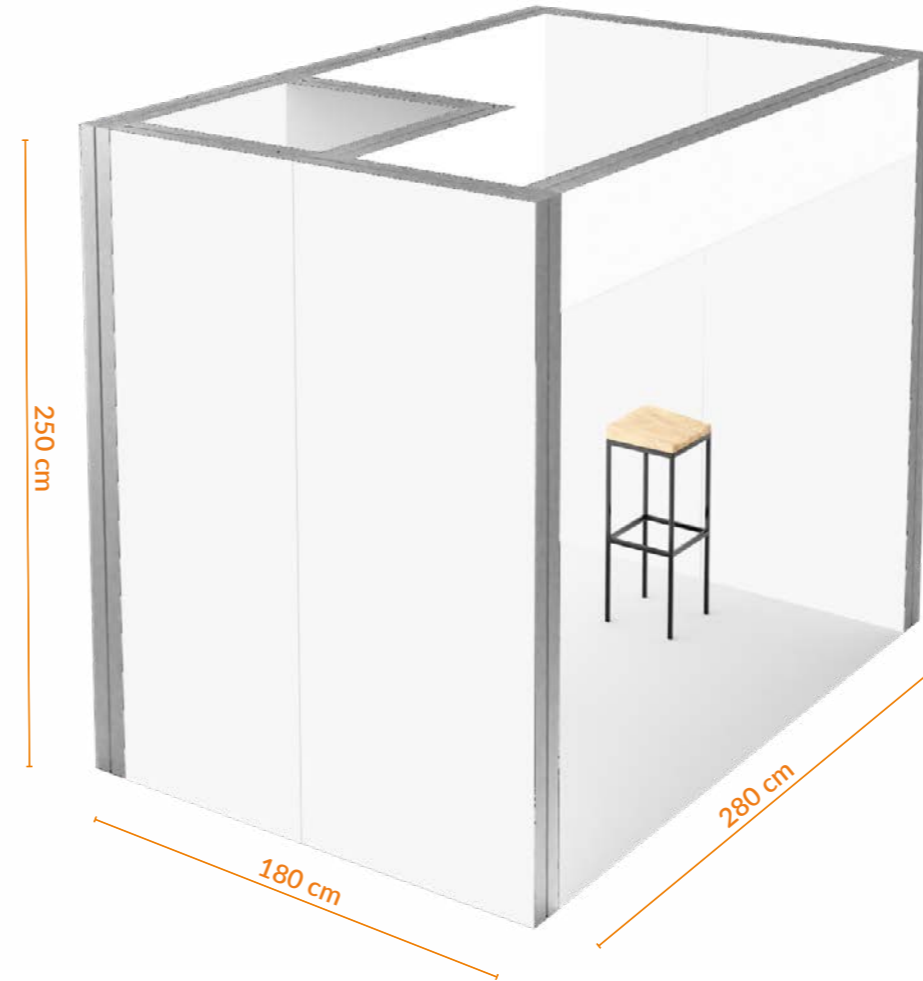

- Wall layout U-SHAPE
- Quick installation

The 3x2 U-SHAPE A exhibition stand is made of aluminium profiles for DIY assembly and carpeting with the print of your choice. As it has three walls and an overhead segment, it is a popular choice in exhibition traffic routes. Comes with all elements required for assembly and an instruction manual.

Information

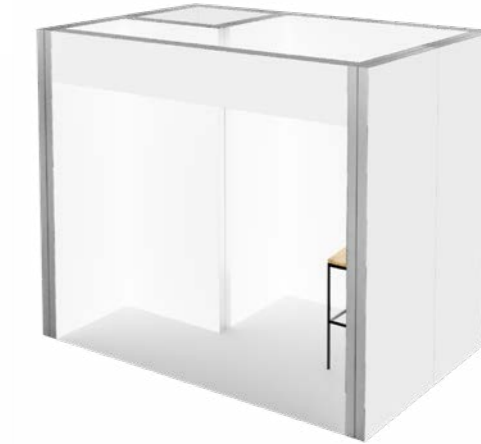

Exhibition Stand [cm]
300x200x250
Total weight [kg]
170

Details

Package dimensions [cm]
9x[255x20x15] + 1x[105x25x25]

Non-equipped stand

modular wall+frieze	9+1pcs
interchangeable fabric with print	6pcs
fitted carpet with print	1pcs

4 013 GBP

Additional equipment

Additional equipment

Ask your advisor about tables, counters, chairs, flyer displays, extension cords or additional lighting. We also offer a range of accessories - advertising cups, flags, rollups, stands, displays and much more.

Write to us - we are at your service!

PROMO STAND

Internal LED backlighting



Interchangeable large-format printed images

Custom-printed Carpet

3x2 L-SHAPE ZEN

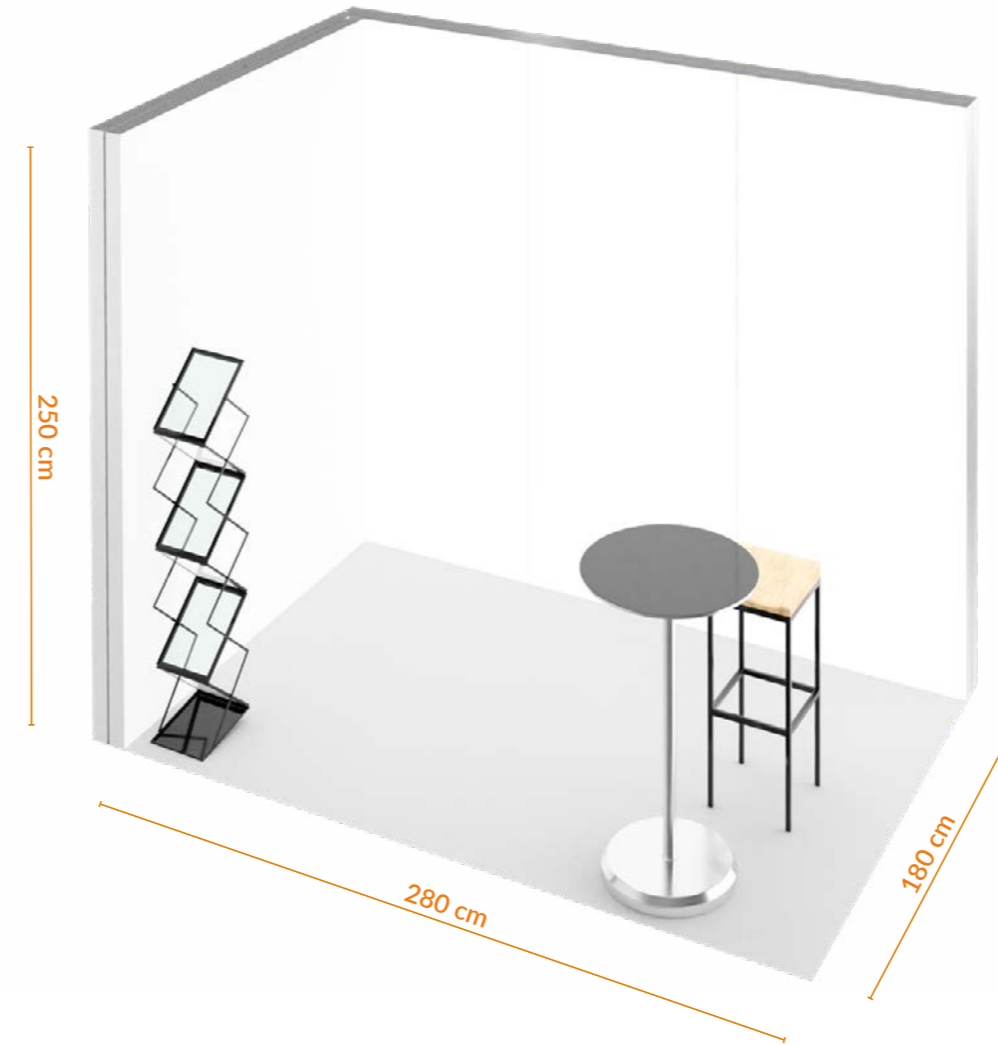

Wall layout L-SHAPE

Quick installation

The 3x2 L-SHAPE ZEN display stand is made of aluminium profiles for DIY assembly and carpeting with the print of your choice. This is a good choice for use in shopping centres or as a compact exhibition stand. Comes with all elements required for assembly and an instruction manual.

Information

Promo Stand [cm]
300x200x250
Total weight [kg]
66



Details

Package dimensions [cm]
5x[255x20x15] + 1x[105x25x25]

Non-equipped stand

modular wall	5pcs
interchangeable fabric with print	2pcs
fitted carpet with print	1pcs

2 067 GBP

Additional equipment

Additional equipment

Ask your advisor about tables, counters, chairs, flyer displays, extension cords or additional lighting. We also offer a range of accessories - advertising cups, flags, rollups, stands, displays and much more.

Write to us - we are at your service!

PROMO STAND



Interchangeable large-format printed images

Internal LED backlighting

Custom-printed Carpet

3x2 U-SHAPE ZEN

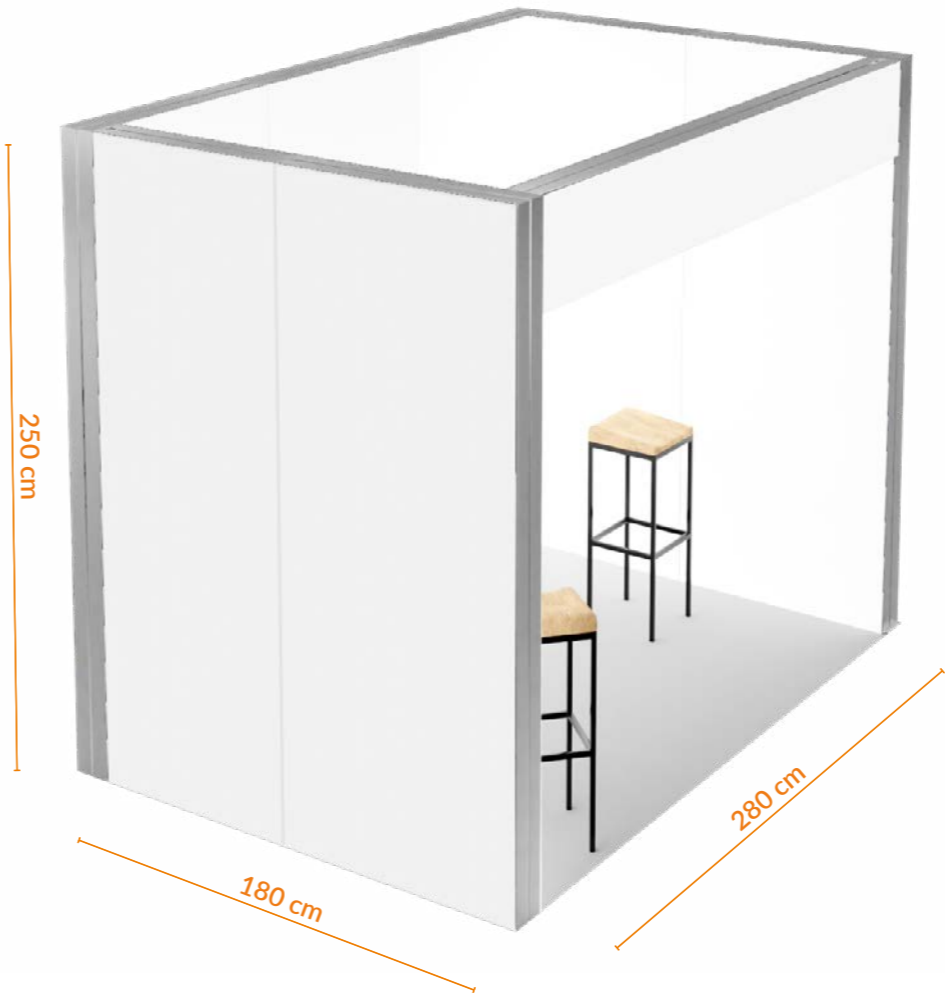

250 cm

180 cm

280 cm

Wall layout U-SHAPE

Quick installation

The 3x2 U-SHAPE ZEN exhibition stand is made of aluminium profiles for DIY assembly and carpeting with the print of your choice. Contrary to the twin "A" version, it does not have a back section and offers slightly more exhibition space instead. As it has three walls and an overhead segment, it is a popular choice in exhibition traffic routes. Comes with all elements required for assembly and an instruction manual.

Information

Promo Stand [cm]
300x200x250
Total weight [kg]
132



Details
Package dimensions [cm]
7x[255x20x15] + 1x[105x25x25]

Non-equipped stand

modular wall+frieze	7+1pcs
interchangeable fabric with print	4pcs
fitted carpet with print	1pcs

4 012,60 GBP

Additional equipment

Ask your advisor about tables, counters, chairs, flyer displays, extension cords or additional lighting. We also offer a range of accessories - advertising cups, flags, rollups, stands, displays and much more.



Write to us - we are at your service!

EXHIBITION STAND



3x3 L-SHAPE



-  **Wall layout L-SHAPE**
-  **Easy Transportation**
-  **Quick installation**

The 3x3 L-SHAPE exhibition stand is made of a light aluminium structure, which is assembled with strong magnets. Comes with carpeting with the print of your choice. The almost 9 m2 offers freedom of display. The structure is foldable and fits in the dedicated bags for much easier transport. Comes with all elements required for assembly and an instruction manual.

Information

Exhibition Stand [cm]
300x300x240
Total weight [kg]
50



Details
Package dimensions [cm]
4x[25x103x13] + 1x[105x25x25]

Non-equipped stand

modular wall	4pcs
interchangeable fabric with print	4pcs
fitted carpet with print	1pcs

 **1 626 GBP**

Additional equipment

Additional equipment

Ask your advisor about tables, counters, chairs, flyer displays, extension cords or additional lighting. We also offer a range of accessories - advertising cups, flags, rollups, stands, displays and much more.

Write to us - we are at your service!

EXHIBITION STAND



LED lighting

Interchangeable large-format printed images

Custom-printed Carpet

The counter is also available with backlight – ask your consultant

3x3 SEMI ISLAND

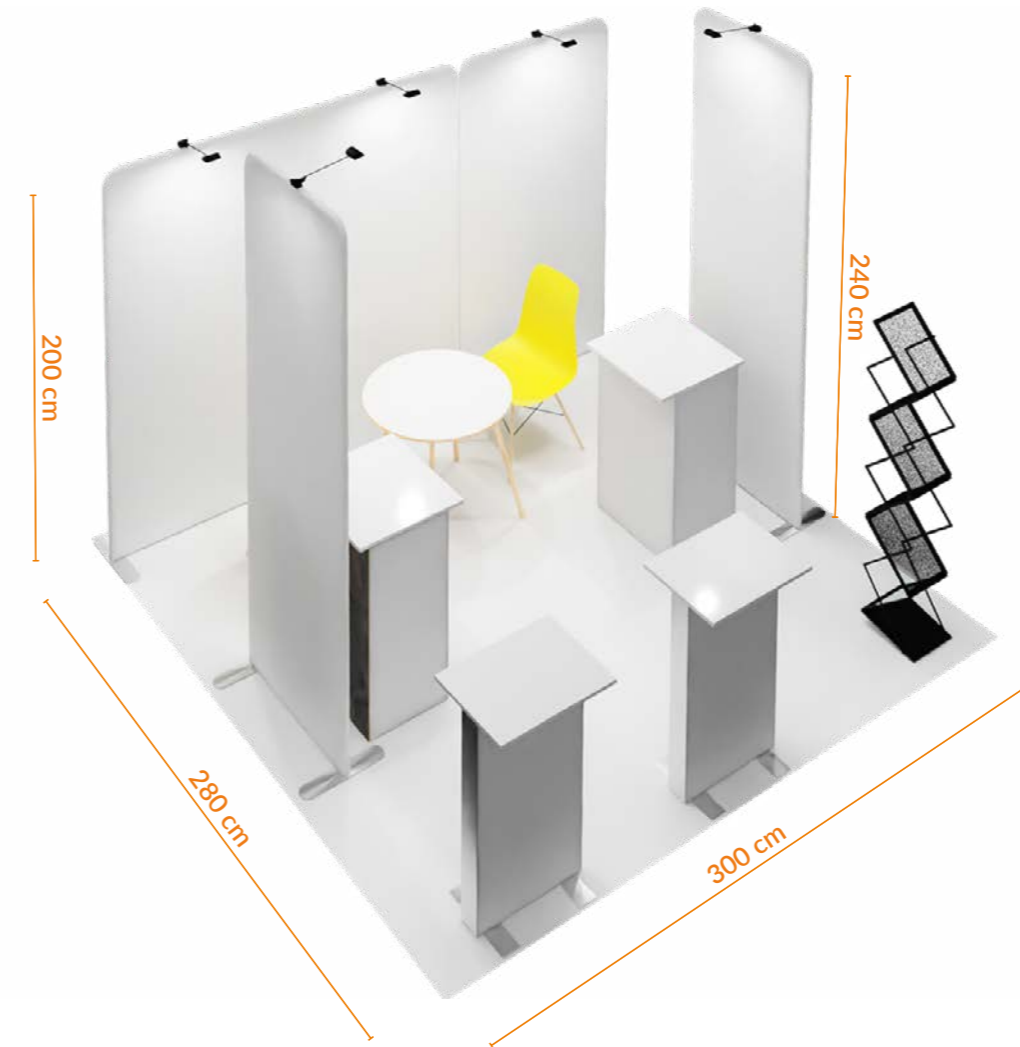

-  **Wall layout SEMI ISLAND**
-  **Easy Transportation**
-  **Quick installation**

The 3x3 SEMI ISLAND exhibition stand is made of a light aluminium structure, which is assembled with strong magnets. Comes with carpeting with the print of your choice. The several partitions of different heights make it possible to arrange the space in a creative manner. The structure is foldable and fits in the dedicated bags for much easier transport. Comes with all elements required for assembly and an instruction manual.

Information

Exhibition Stand [cm]
300x300x240
Total weight [kg]
45



Details
Package dimensions [cm]
2x[25x103x13] + 2x[105x25x25]

Non-equipped stand

modular wall	4pcs
interchangeable fabric with print	4pcs
fitted carpet with print	1pcs

1 300 GBP

Additional equipment

Additional equipment

Ask your advisor about tables, counters, chairs, flyer displays, extension cords or additional lighting. We also offer a range of accessories - advertising cups, flags, rollups, stands, displays and much more.

Write to us - we are at your service!

EXHIBITION STAND



3x3 SEMI ISLAND A



Information

Exhibition Stand [cm]
300x300x240
Total weight [kg]
48



Details

Package dimensions [cm]
4x[25x103x13] + 2x[105x25x25]



Non-equipped stand

modular wall	4pcs
interchangeable fabric with print	4pcs
fitted carpet with print	1pcs

1 743 GBP



Additional equipment

Ask your advisor about tables, counters, chairs, flyer displays, extension cords or additional lighting. We also offer a range of accessories - advertising cups, flags, rollups, stands, displays and much more.

Write to us - we are at your service!

- Wall layout SEMI ISLAND**
- Easy Transportation**
- Quick installation**

The 3x3 SEMI ISLAND A exhibition stand is made of a light aluminium structure, which is assembled with strong magnets. Comes with carpeting with the print of your choice. The two irregularly shaped walls are attractive and encourage creative selection of the graphics. They also make up a small back section. The structure is foldable and fits in the dedicated bags for much easier transport. Comes with all elements required for assembly and an instruction manual.

EXHIBITION STAND

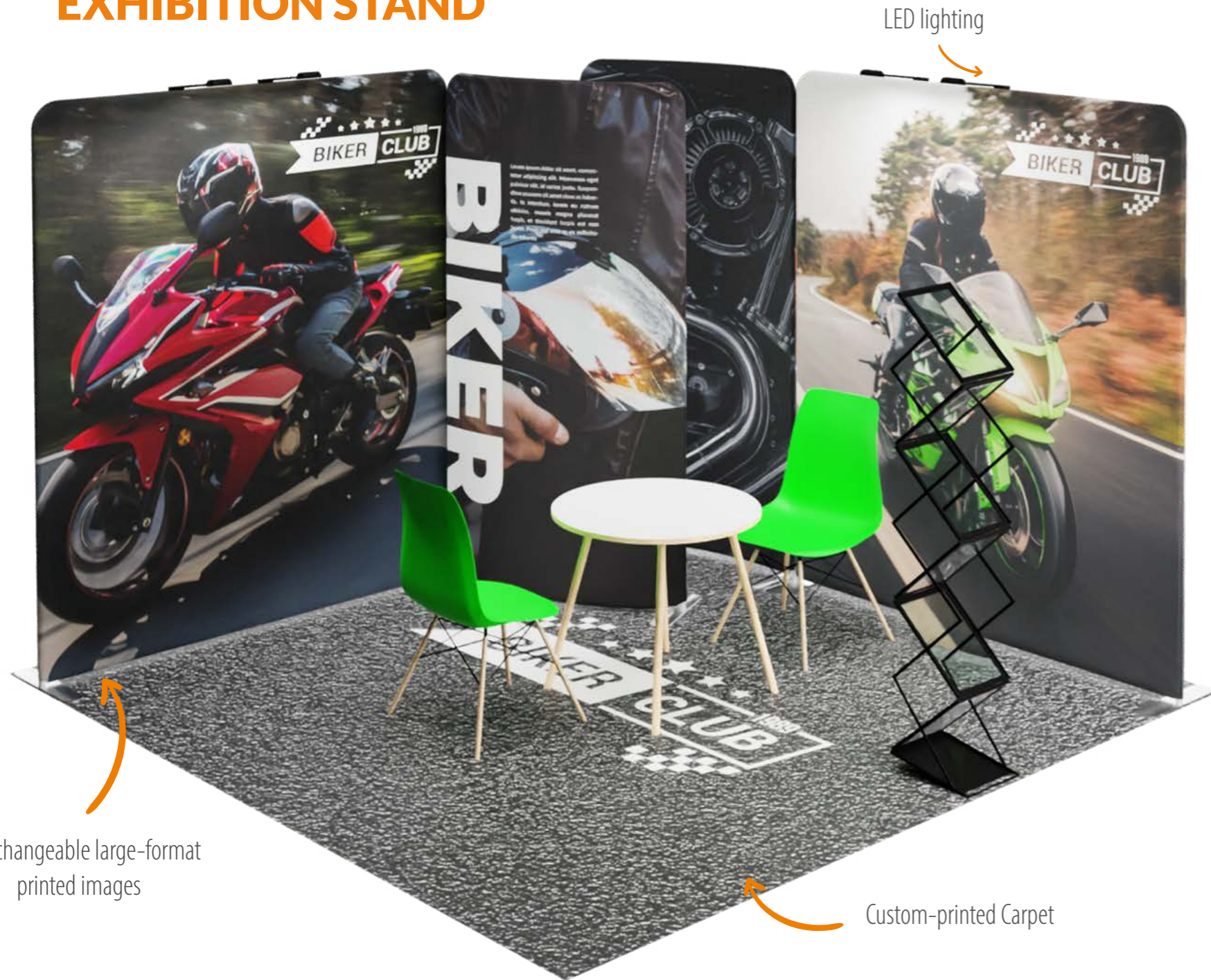

Interchangeable large-format printed images

Custom-printed Carpet

3x3 SEMI ISLAND B

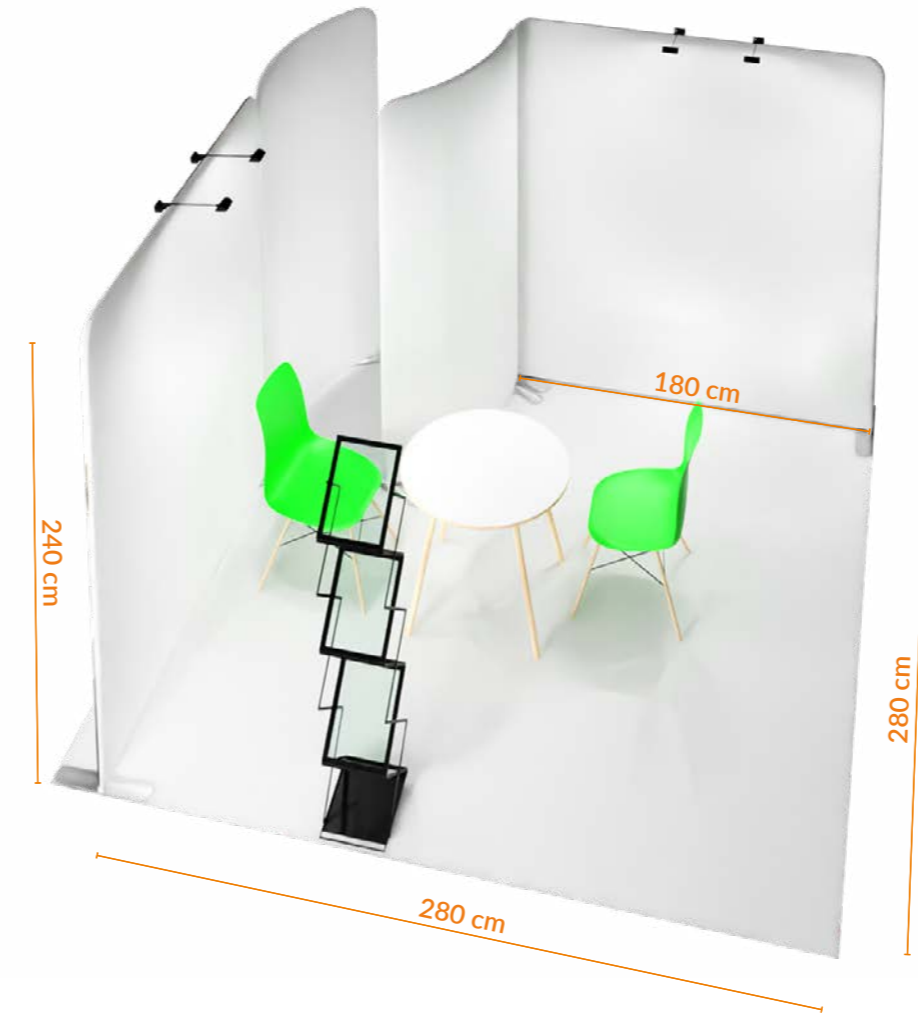

-  **Wall layout SEMI ISLAND**
-  **Easy Transportation**
-  **Quick installation**

The 3x3 SEMI ISLAND B exhibition stand is made of a light aluminium structure, which is assembled with strong magnets. Comes with carpeting with the print of your choice. The stand is open on two sides and has a small back section. An excellent choice for small exhibition space. The structure is foldable and fits in the dedicated bags for much easier transport. Comes with all elements required for assembly and an instruction manual.

Information

Exhibition Stand [cm]
300x300x240
Total weight [kg]
51



Details
Package dimensions [cm]
4x[25x103x13] + 2x[105x25x25]

Non-equipped stand

modular wall	4pcs
interchangeable fabric with print	4pcs
fitted carpet with print	1pcs

1 960 GBP

Additional equipment

Additional equipment

Ask your advisor about tables, counters, chairs, flyer displays, extension cords or additional lighting. We also offer a range of accessories - advertising cups, flags, rollups, stands, displays and much more.

Write to us - we are at your service!

EXHIBITION STAND

Internal LED backlighting



Interchangeable large-format printed images

Custom-printed Carpet

3x3 L-SHAPE ZEN

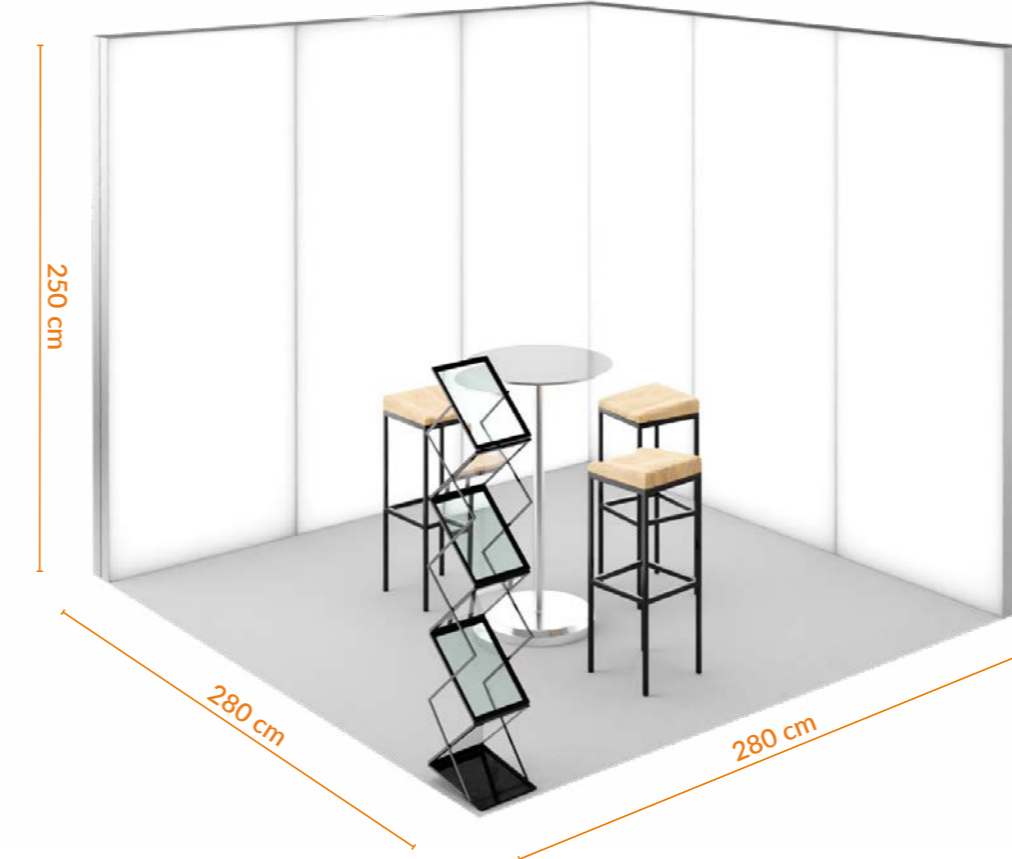

- Wall layout L-SHAPE
- Quick installation

The 3x3 L-SHAPE ZEN exhibition stand is made of aluminium profiles for DIY assembly and carpeting with the print of your choice. The stand is open on two sides and has big backlit walls. It is very popular for smaller exhibition space. Comes with all elements required for assembly and an instruction manual.



Information

Exhibition Stand [cm]
300x300x250
Total weight [kg]
104



Details
Package dimensions [cm]
6x[255x20x15] + 2x[105x25x25]



Non-equipped stand

modular wall	6pcs
interchangeable fabric with print	2pcs
fitted carpet with print	1pcs

1 966 GBP



Additional equipment

Ask your advisor about tables, counters, chairs, flyer displays, extension cords or additional lighting. We also offer a range of accessories - advertising cups, flags, rollups, stands, displays and much more.

Write to us - we are at your service!

EXHIBITION STAND

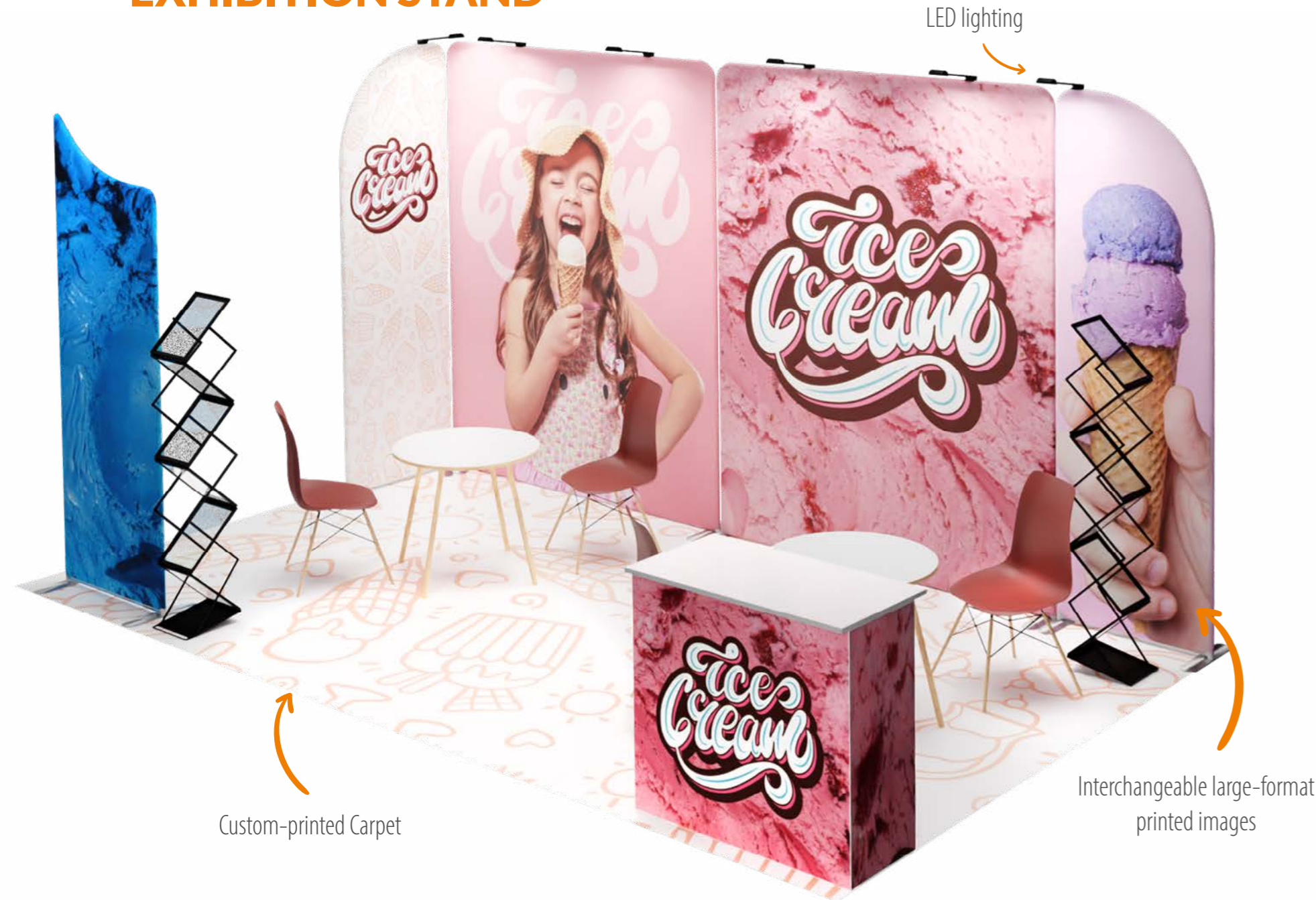

Custom-printed Carpet

LED lighting

Interchangeable large-format printed images

3x5 SEMI ISLAND

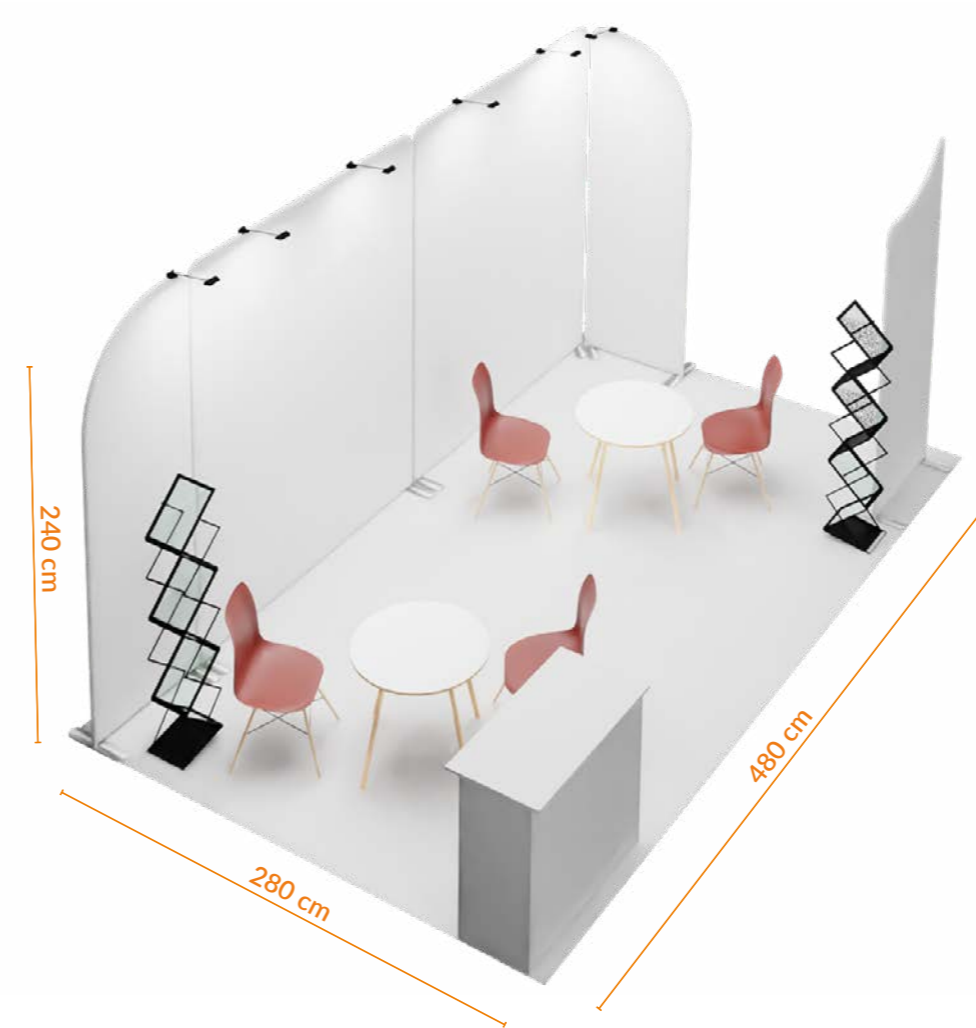

Wall layout SEMI ISLAND

Easy Transportation

Quick installation

The 3x5 SEMI ISLAND exhibition stand is made of a light aluminium structure, which is assembled with strong magnets. Comes with carpeting with the print of your choice. The additional freestanding irregularly shaped partition can be set up anywhere. The structure is foldable and fits in the dedicated bags for much easier transport. Comes with all elements required for assembly and an instruction manual.

Information

Exhibition Stand [cm]
300x500x240
Total weight [kg]
60



Details
Package dimensions [cm]
5x[25x103x13] + 3x[105x25x25]

Non-equipped stand

modular wall	6pcs
interchangeable fabric with print	6pcs
fitted carpet with print	1pcs

2 243 GBP

Additional equipment

Additional equipment

Ask your advisor about tables, counters, chairs, flyer displays, extension cords or additional lighting. We also offer a range of accessories - advertising cups, flags, rollups, stands, displays and much more.

Write to us - we are at your service!

EXHIBITION STAND

Interchangeable large-format printed images

LED lighting



Custom-printed Carpet

3x5 SEMI ISLAND A

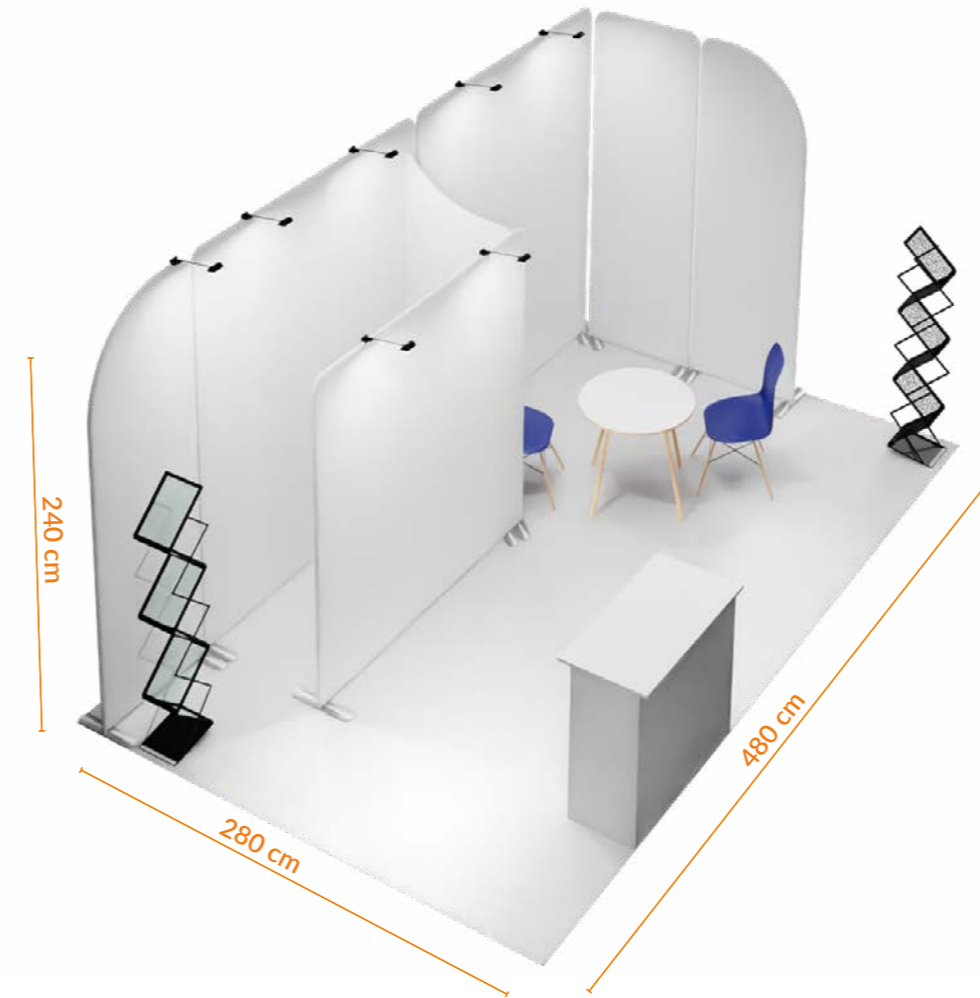

-  **Wall layout SEMI ISLAND**
-  **Easy Transportation**
-  **Quick installation**

The 3x5 SEMI ISLAND A exhibition stand is made of a light aluminium structure, which is assembled with strong magnets. Comes with carpeting with the print of your choice. Compared to the basic version, it has a bigger back section and is shaped like an L. The structure is foldable and fits in the dedicated bags for much easier transport. Comes with all elements required for assembly and an instruction manual.

Information

Exhibition Stand [cm]
300x500x240
Total weight [kg]
75

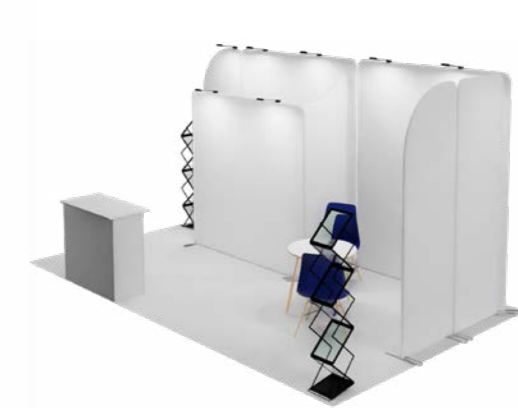

Details
Package dimensions [cm]
7x[25x103x13] + 3x[105x25x25]

Non-equipped stand

modular wall	7pcs
interchangeable fabric with print	7pcs
fitted carpet with print	1pcs

3 125 GBP

Additional equipment

Ask your advisor about tables, counters, chairs, flyer displays, extension cords or additional lighting. We also offer a range of accessories - advertising cups, flags, rollups, stands, displays and much more.

Write to us - we are at your service!

EXHIBITION STAND

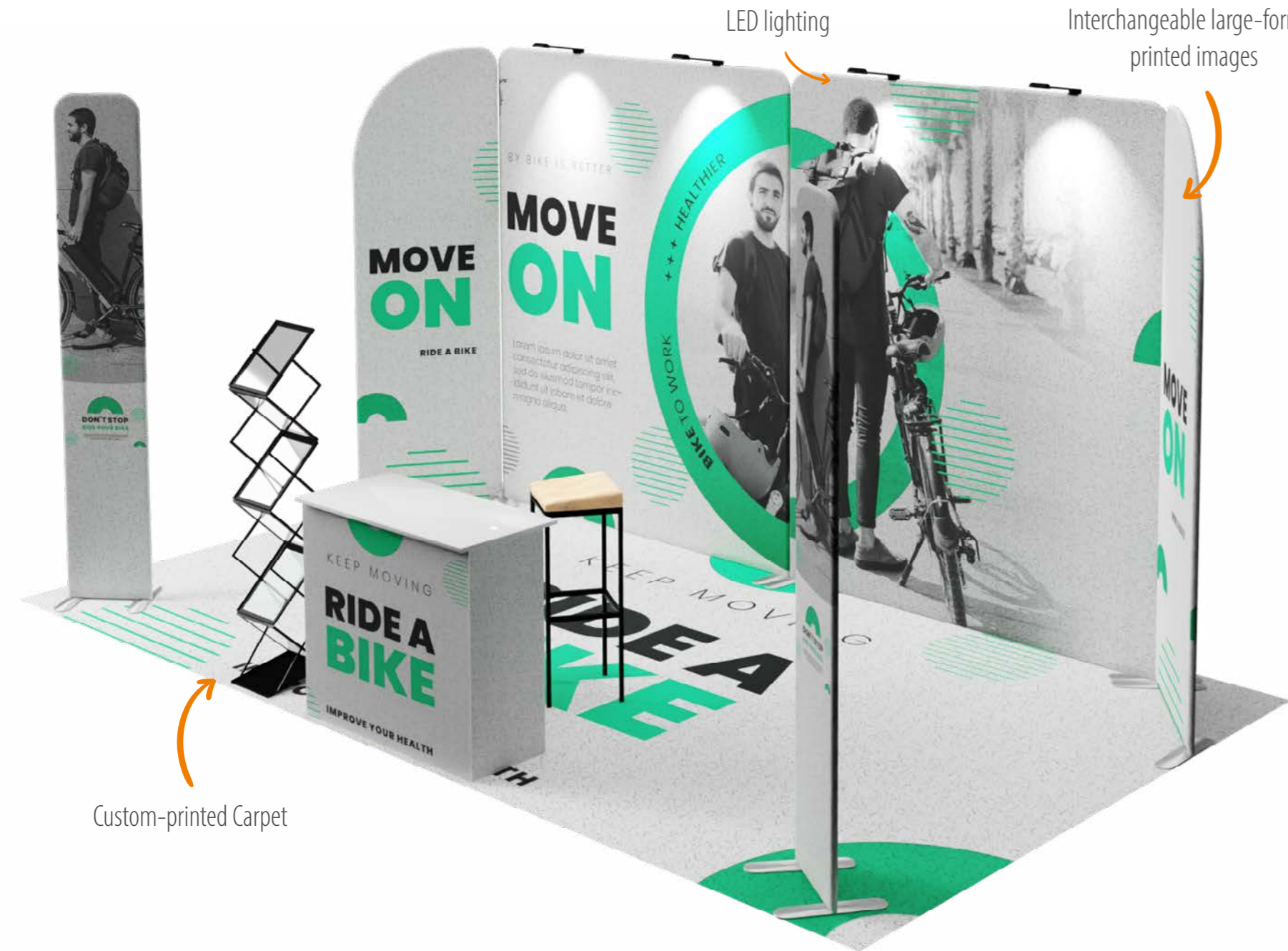

3x5 SEMI ISLAND B

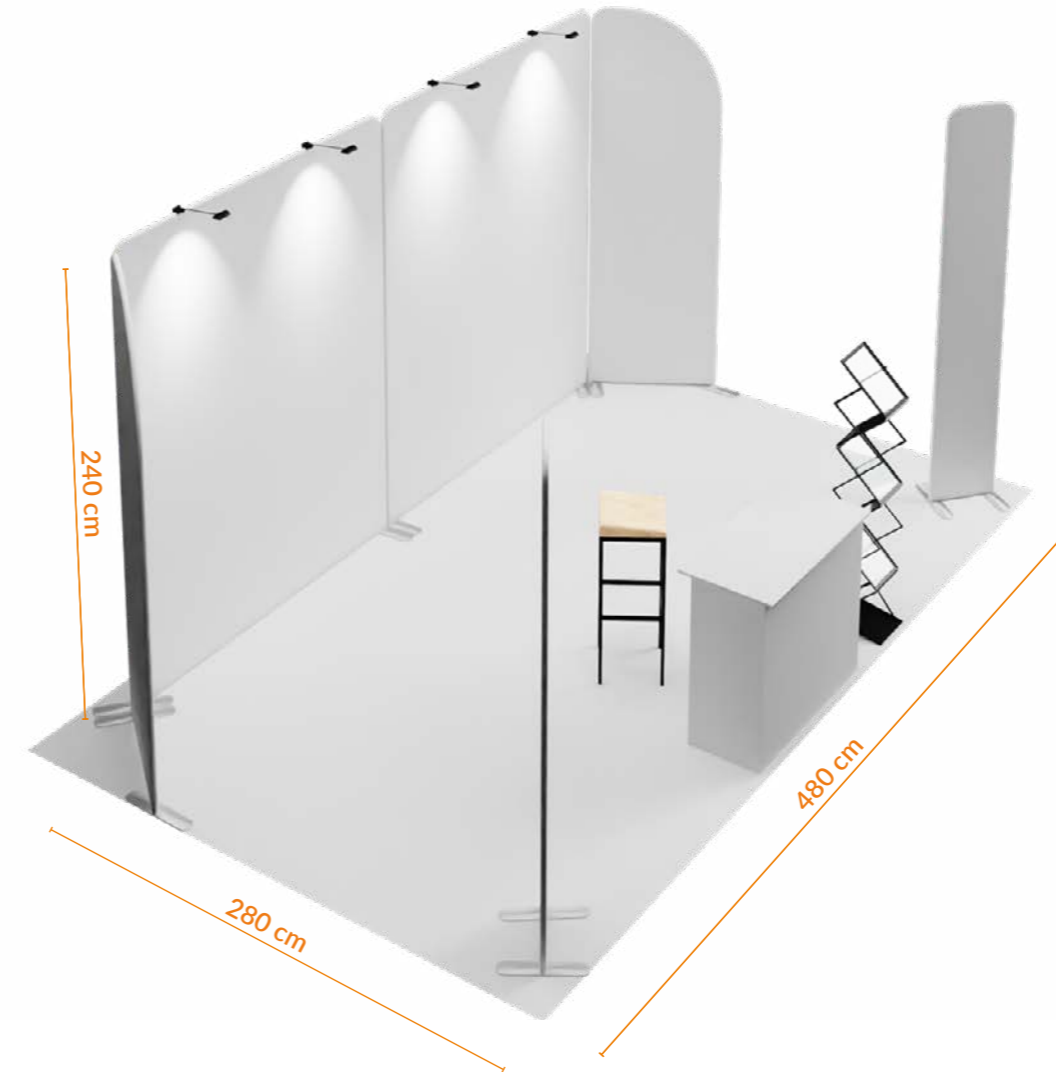

-  **Wall layout SEMI ISLAND**
-  **Easy Transportation**
-  **Quick installation**

The 3x5 SEMI ISLAND B exhibition stand is made of a light aluminium structure, which is assembled with strong magnets. Comes with carpeting with the print of your choice. The stand is open on three sides, covers almost 15 m2, and is arranged in a convenient way, which makes it easy to plan out equipment locations. The structure is foldable and fits in the dedicated bags for much easier transport. Comes with all elements required for assembly and an instruction manual.

Information

Exhibition Stand [cm]
300x500x240
Total weight [kg]
75



Details

Package dimensions [cm]
6x[25x103x13] + 3x[105x25x25]

Non-equipped stand

modular wall	6pcs
interchangeable fabric with print	6pcs
fitted carpet with print	1pcs

2 525 GBP

Additional equipment

Ask your advisor about tables, counters, chairs, flyer displays, extension cords or additional lighting. We also offer a range of accessories - advertising cups, flags, rollups, stands, displays and much more.

Write to us - we are at your service!

EXHIBITION STAND



3x5 SEMI ISLAND C



Information

Exhibition Stand [cm]
300x500x240
Total weight [kg]
75



Details
Package dimensions [cm]
6x[25x103x13] + 3x[105x25x25]

Non-equipped stand

modular wall	6pcs
interchangeable fabric with print	6pcs
fitted carpet with print	1pcs

2 674 GBP

Additional equipment

Additional equipment

Ask your advisor about tables, counters, chairs, flyer displays, extension cords or additional lighting. We also offer a range of accessories - advertising cups, flags, rollups, stands, displays and much more.

Write to us - we are at your service!

- Wall layout SEMI ISLAND
- Easy Transportation
- Quick installation

The 3x5 SEMI ISLAND C exhibition stand is made of a light aluminium structure, which is assembled with strong magnets. Comes with carpeting with the print of your choice. The stand is open on three sides and has an irregular and interestingly arranged back section. The structure is foldable and fits in the dedicated bags for much easier transport. Comes with all elements required for assembly and an instruction manual.

EXHIBITION STAND



3x5 L-SHAPE ZEN

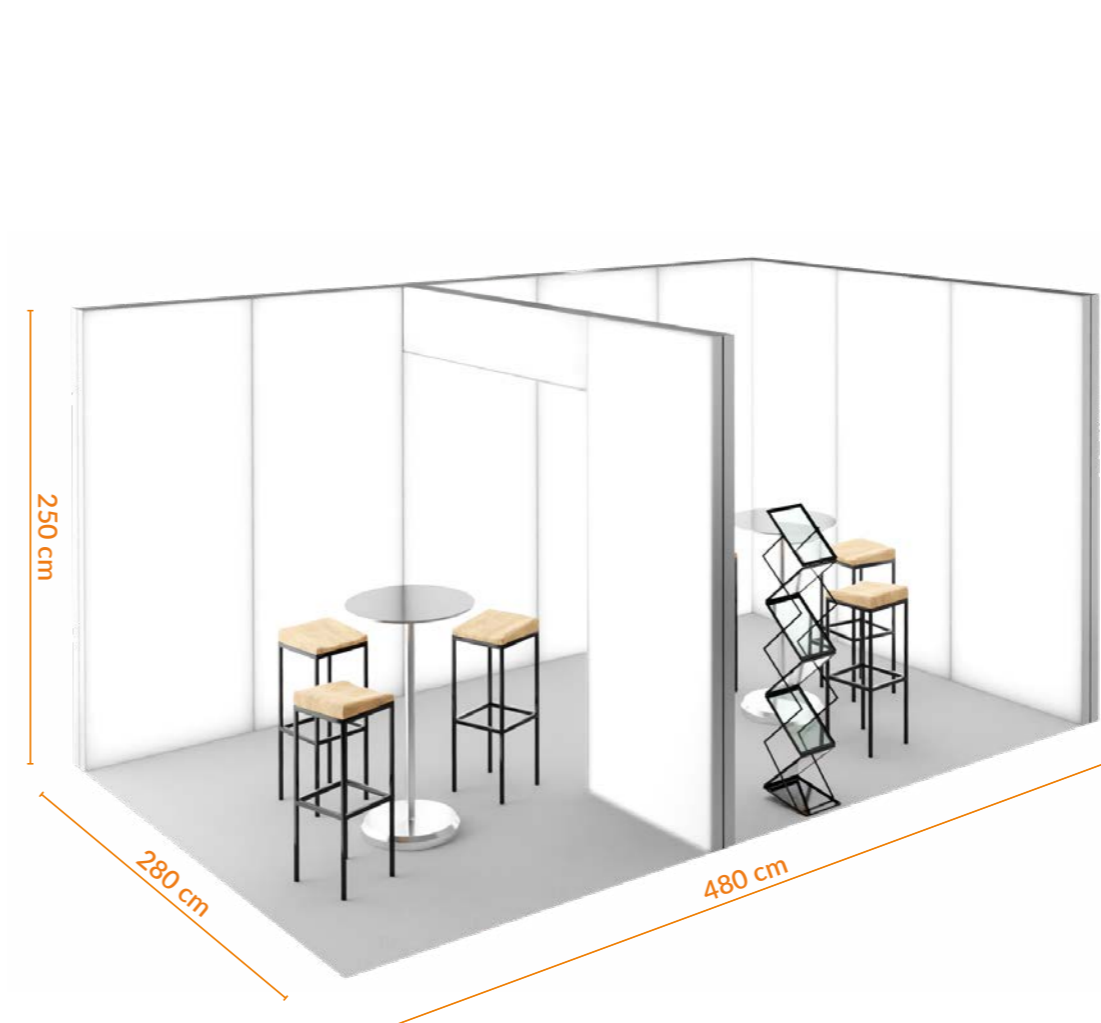

Information

Exhibition Stand [cm]
300x500x250
Total weight [kg]
280



Details
Package dimensions [cm]
9x[255x20x15] + 3x[105x25x25]

Non-equipped stand

modular wall+frieze	9+2pcs
interchangeable fabric with print	6pcs
fitted carpet with print	1pcs

5 324 GBP

Additional equipment

Ask your advisor about tables, counters, chairs, flyer displays, extension cords or additional lighting. We also offer a range of accessories - advertising cups, flags, rollups, stands, displays and much more.

Write to us - we are at your service!

- Wall layout L-SHAPE
- Quick installation

The 3x5 L-SHAPE ZEN exhibition stand is made of aluminium profiles for DIY assembly and carpeting with the print of your choice. The stand is open on two sides and has an attractive partition in the middle to split the space in half. Comes with all elements required for assembly and an instruction manual.

EXHIBITION STAND



The counter is also available with backlight – ask your consultant

4x4 ISLAND

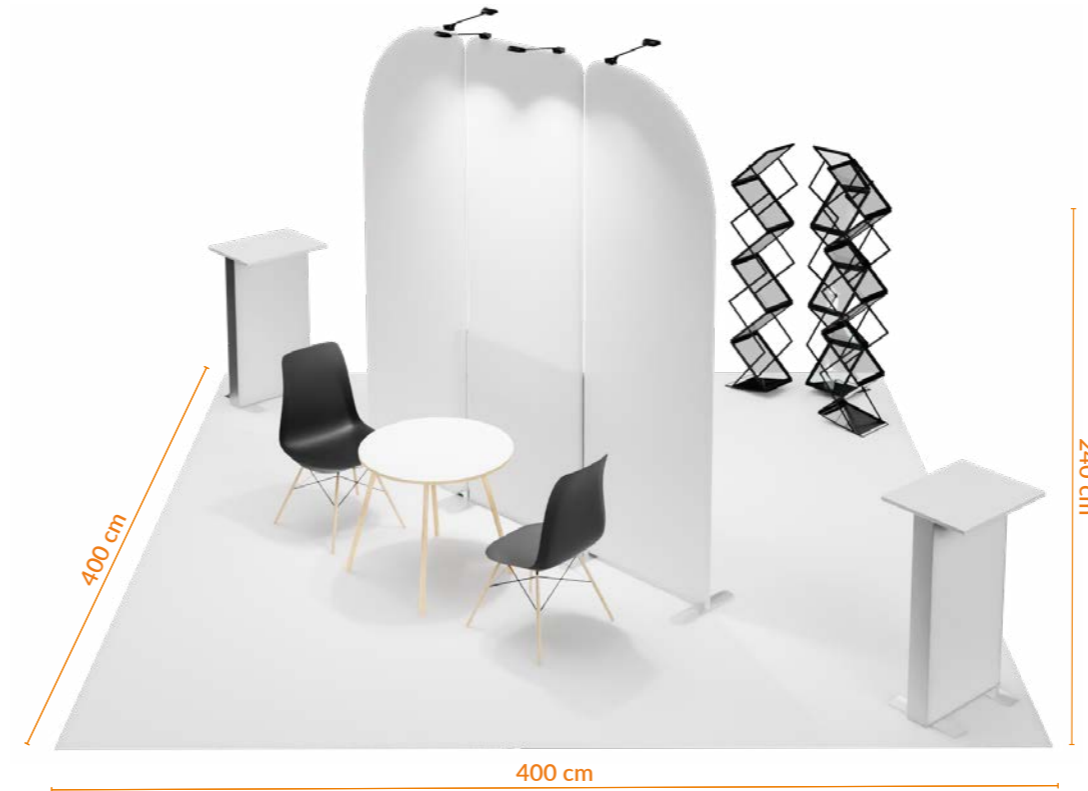

-  **Wall layout ISLAND**
-  **Easy Transportation**
-  **Quick installation**

The 4x4 ISLAND exhibition stand is made of a light aluminium structure, which is assembled with strong magnets. Comes with carpeting with the print of your choice. An island-type stand with two allocated conversation zones. The perfect choice for a shopping centre or exhibition island. The structure is foldable and fits in the dedicated bags for much easier transport. Comes with all elements required for assembly and an instruction manual.

Information

Exhibition Stand [cm]
400x400x240
Total weight [kg]
44



Details
Package dimensions [cm]
3x[25x103x13] + 3x[105x25x25]

Non-equipped stand

modular wall	3pcs
interchangeable fabric with print	3pcs
fitted carpet with print	1pcs

1 160 GBP

Additional equipment

Additional equipment

Ask your advisor about tables, counters, chairs, flyer displays, extension cords or additional lighting. We also offer a range of accessories - advertising cups, flags, rollups, stands, displays and much more.

Write to us - we are at your service!

EXHIBITION STAND

Interchangeable large-format printed images

LED lighting



Custom-printed Carpet

The counter is also available with backlight – ask your consultant

Counter also available with illumination - ask your consultant

The images in the catalogue are for illustrative purposes only and the appearance of individual accessories may vary throughout the year, depending on availability.

4x4 L-SHAPE

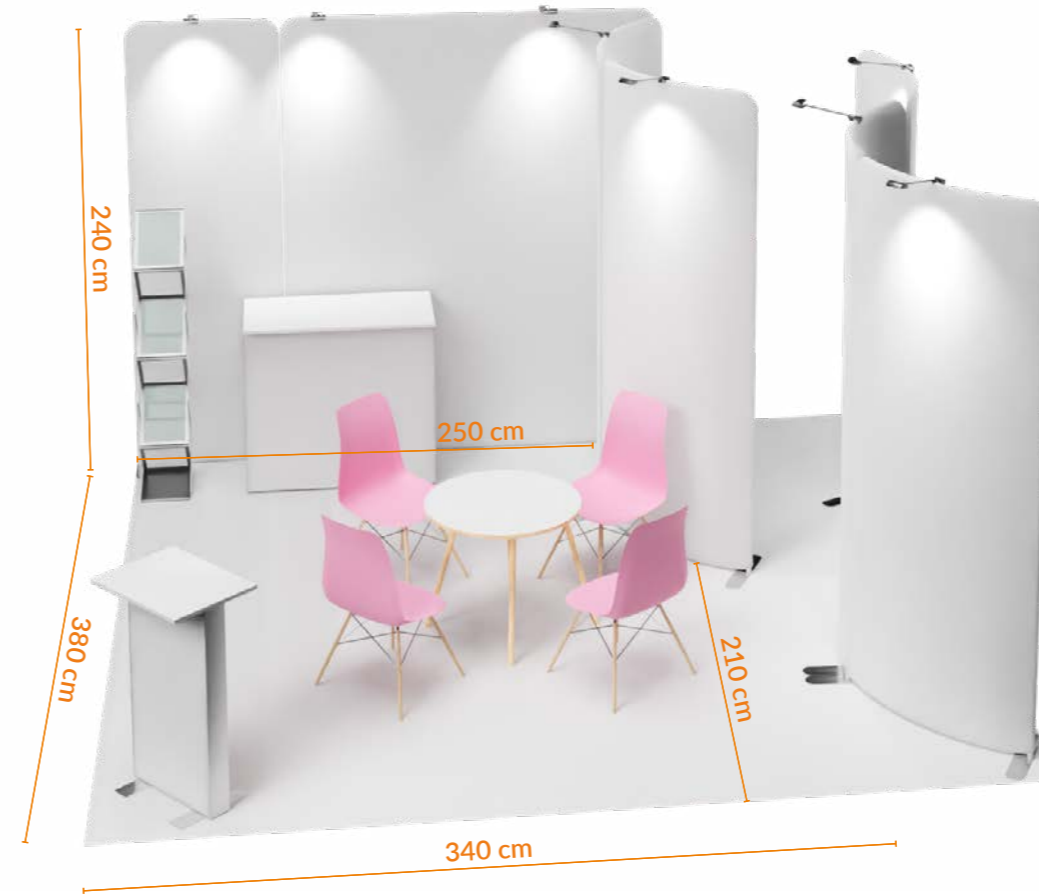

-  **Wall layout L-SHAPE**
-  **Easy Transportation**
-  **Quick installation**

The 4x4 L-SHAPE exhibition stand is made of a light aluminium structure, which is assembled with strong magnets. Comes with carpeting with the print of your choice. The backlit partitions are designed to serve as visual attractions and a semi-circular back section and to allow for convenient equipment arrangement. The structure is foldable and fits in the dedicated bags for much easier transport. Comes with all elements required for assembly and an instruction manual.



Information

Exhibition Stand [cm]
400x400x240
Total weight [kg]
80



Details
Package dimensions [cm]
7x[25x103x13] + 3x[105x25x25]



Non-equipped stand

modular wall	7pcs
interchangeable fabric with print	7pcs
fitted carpet with print	1pcs

 **2 593 GBP**



Additional equipment

Ask your advisor about tables, counters, chairs, flyer displays, extension cords or additional lighting. We also offer a range of accessories - advertising cups, flags, rollups, stands, displays and much more.

Write to us - we are at your service!



Application:

- Islands in the galleries
- Business conferences
- Promotions in supermarkets
- Trade fair stands

EXHIBITION STAND



5x5 ISLAND ZEN

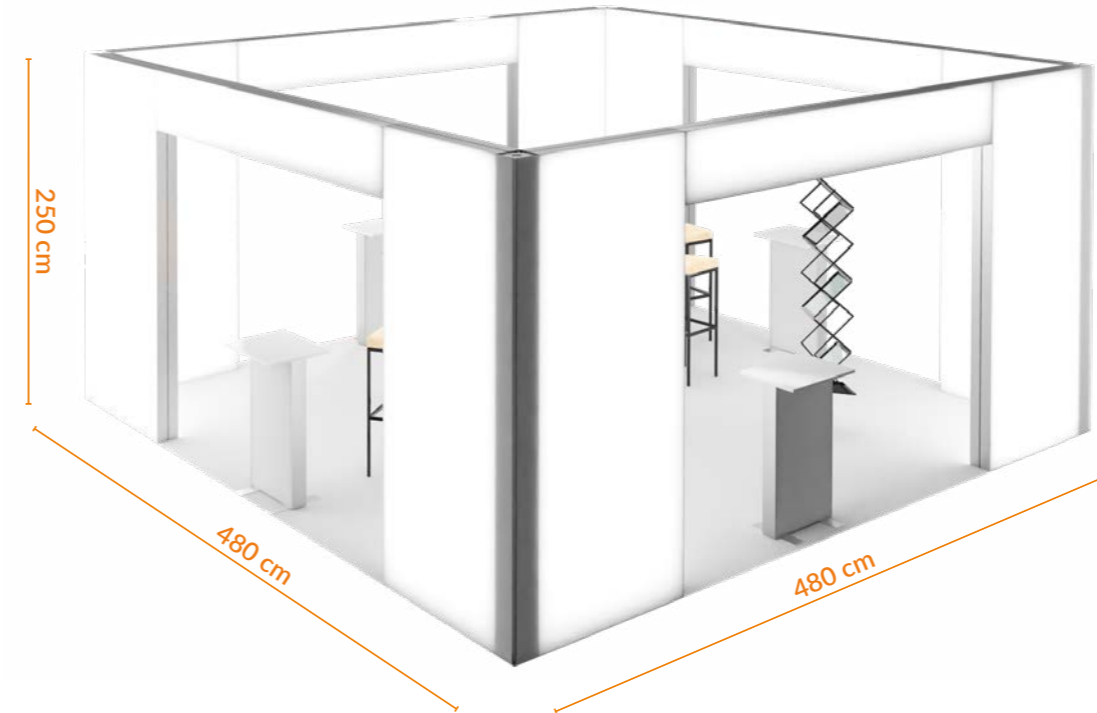

- Wall layout ISLAND
- Quick installation

The 5x5 ISLAND ZEN exhibition stand is made of aluminium profiles for DIY assembly and carpeting with the print of your choice. This is a big and spacious stand with walls of an attractive shape allowing for plenty of creativity in designing graphics. Comes with all elements required for assembly and an instruction manual.

Information

Exhibition Stand [cm]
500x500x250
Total weight [kg]
350

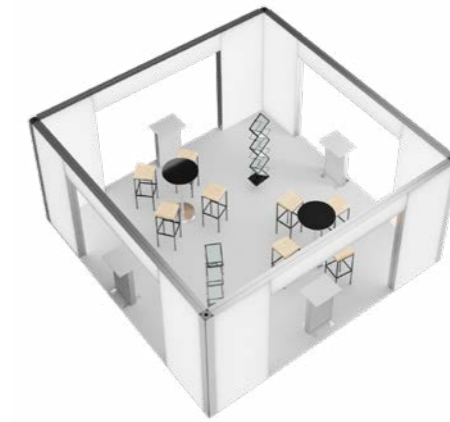

Details
Package dimensions [cm]
8x[255x20x15] + 5x[105x25x25]
+ 2x[290 x20x15]

Non-equipped stand

modular wall+frieze	8+8pcs
interchangeable fabric with print	24pcs
fitted carpet with print	1pcs

5 732 GBP

Additional equipment

Ask your advisor about tables, counters, chairs, flyer displays, extension cords or additional lighting. We also offer a range of accessories - advertising cups, flags, rollups, stands, displays and much more.

Write to us - we are at your service!

EXHIBITION STAND



5x5 ISLAND ZEN A

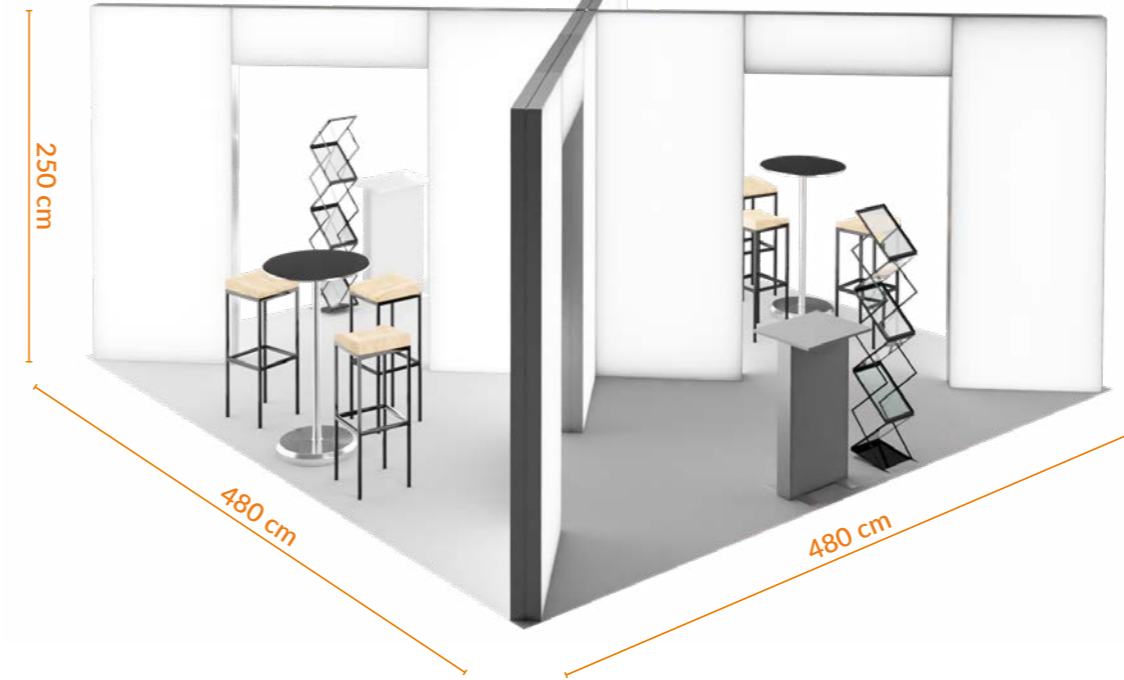

- Wall layout ISLAND
- Quick installation

The 5x5 ISLAND ZEN A exhibition stand is made of aluminium profiles for DIY assembly and carpeting with the print of your choice. This is a big and spacious stand. Contrary to the basic version, the partitions are set up diagonally, which divides the space in a natural manner and creates four separate conversation spaces. Comes with all elements required for assembly and an instruction manual.

Information

Exhibition Stand [cm]
500x500x250
Total weight [kg]
310

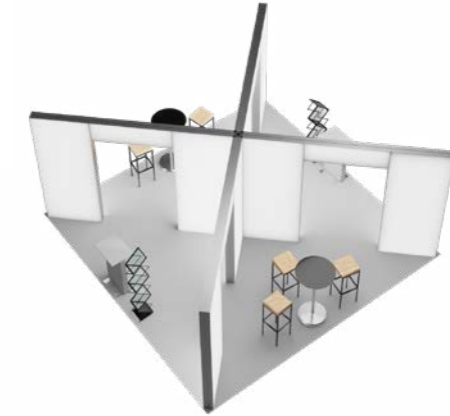

Details
Package dimensions [cm]
8x[255x20x15] + 5x[105x25x25]

Non-equipped stand

modular wall+frieze	8+8pcs
interchangeable fabric with print	24pcs
fitted carpet with print	1pcs

5 506 GBP

Additional equipment

Ask your advisor about tables, counters, chairs, flyer displays, extension cords or additional lighting. We also offer a range of accessories - advertising cups, flags, rollups, stands, displays and much more.

Write to us - we are at your service!

EXHIBITION STAND



6x4 L-SHAPE

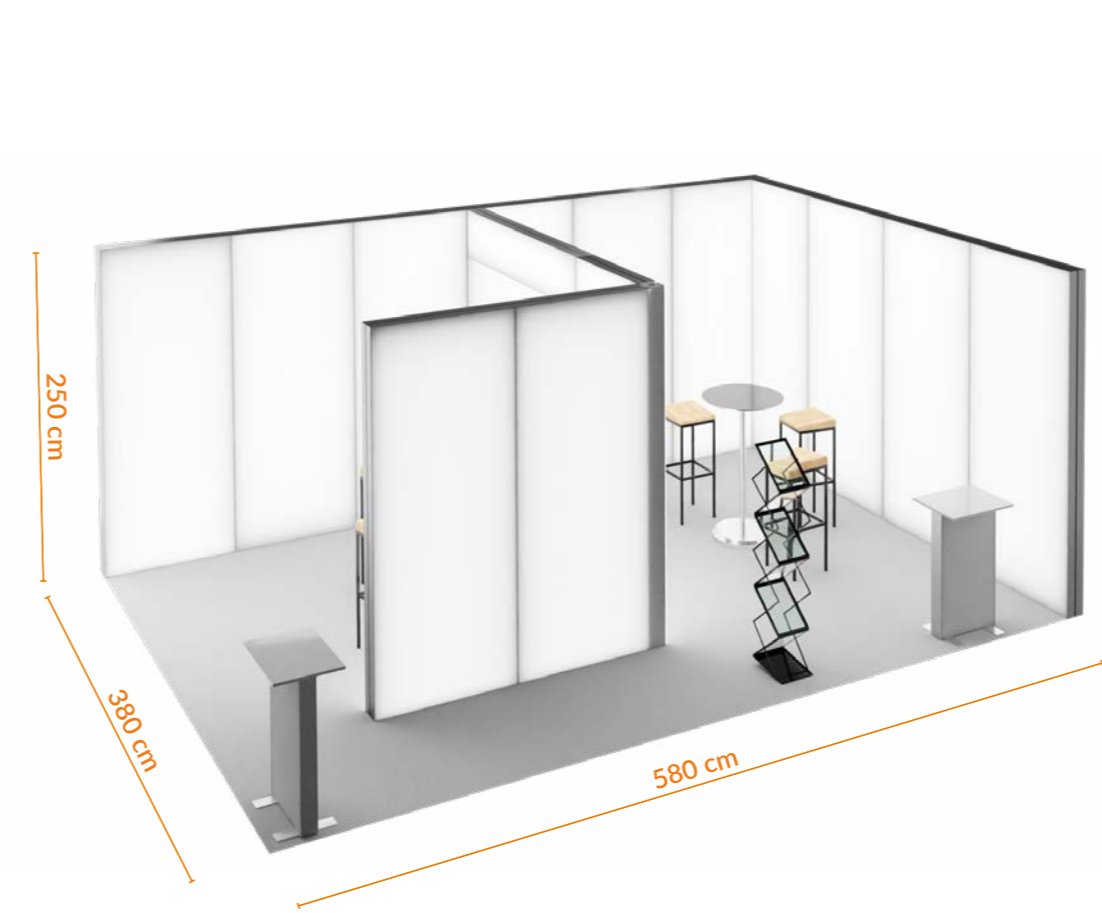

- Wall layout L-SHAPE
- Quick installation

The 6x4 L-SHAPE exhibition stand is made of aluminium profiles for DIY assembly and carpeting with the print of your choice. This is the biggest stand in our offer of ready to use solutions. 22 m2 of space split with an irregular partition to form several separate sections for conversations and plenty of graphics display space. Comes with all elements required for assembly and an instruction manual.

	Information	Exhibition Stand [cm] 600x400x250
		Total weight [kg] 400



Details	Package dimensions [cm]
	13x[255x20x15] + 4x[105x25x25]

	Non-equipped stand	
modular wall+frieze		13+1pcs
interchangeable fabric with print		9 pcs
fitted carpet with print		1pcs

7 082 GBP

Additional equipment
Ask your advisor about tables, counters, chairs, flyer displays, extension cords or additional lighting. We also offer a range of accessories - advertising cups, flags, rollups, stands, displays and much more.

Write to us - we are at your service!

Counter also available with illumination - ask your consultant
The images in the catalogue are for illustrative purposes only and the appearance of individual accessories may vary throughout the year, depending on availability.



Application:



- Promotions in supermarkets
- Trade fair stands
- Shopping malls

FURNISHINGS

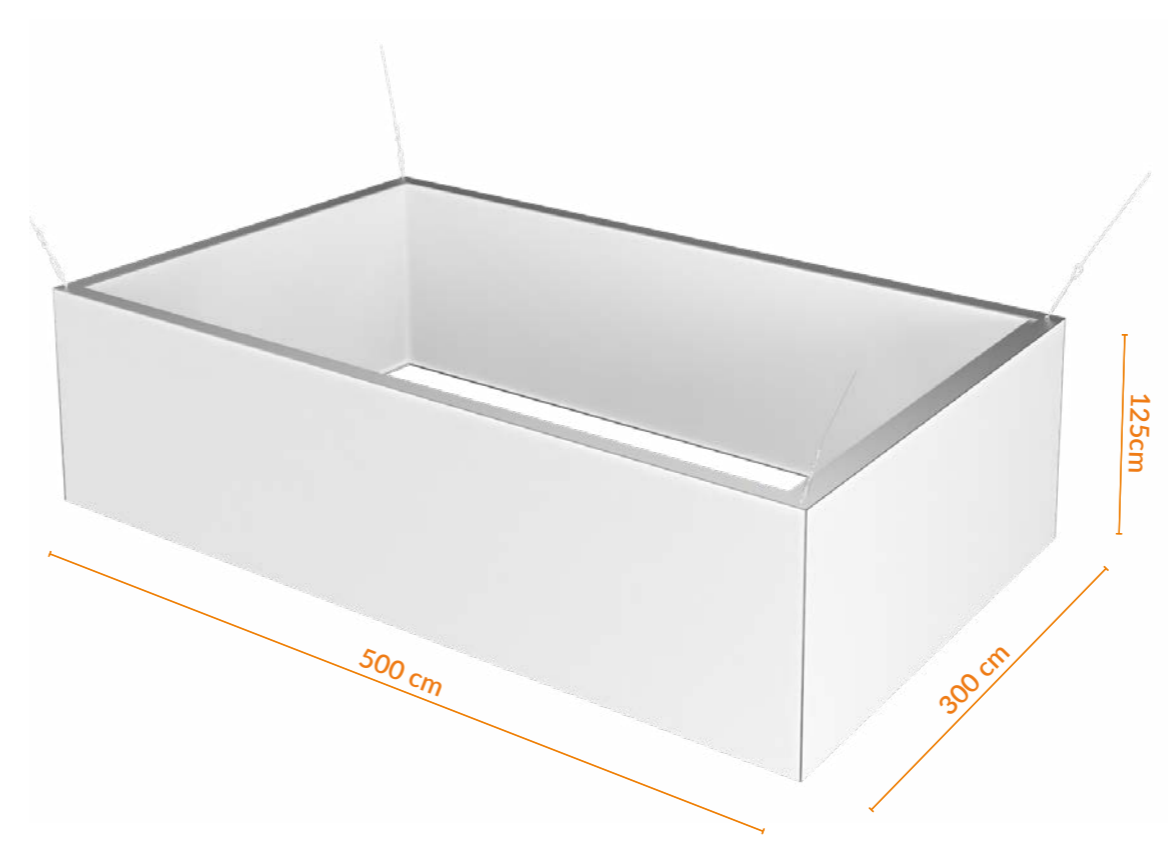

3x5 ZEN



-  **Shape: TYPE "O"**
-  **Quick installation**

The textile 3x5 ZEN suspension system complements our offer for exhibitors and organisers of events, galas, and conferences. It makes for easier orientation of guests at events. The Zen system is made of high quality aluminium alloys. The systems are light, which makes them easy to suspend from load bearing structures.

Information

System dimensions from visualization [cm]
300x500x125cm

Total weight [kg]
32,1kg

Details

Package dimensions [cm]
1x[30x30x310] + 2x[30x30x110]



Other sizes available

Dimensions	Price
200x200x100	688 GBP
300x300x125	1 050 GBP
200x400x150	1 222 GBP
300x600x150	1 642 GBP
400x400x150	1 462 GBP
600x600x200	2 312 GBP

Set price

Suspended systems	1pcs
interchangeable fabric with print	4pcs
fabric without print	4pcs
Metal holders	3pcs
Spring hooks	3pcs
Lines for installation (2m each)	3pcs

1 640 GBP

Additional equipment

Need more accessories for your stall? Would you like to stand out to attract the visitors? Check out what's available in our offer. Choose from: flags, advertising cups, roll ups, countertop displays. And many more...

FURNISHINGS



Durable suspension

Aesthetically finished profile

Interchangeable large-format printed images

3x5 ZEN CUSTOM

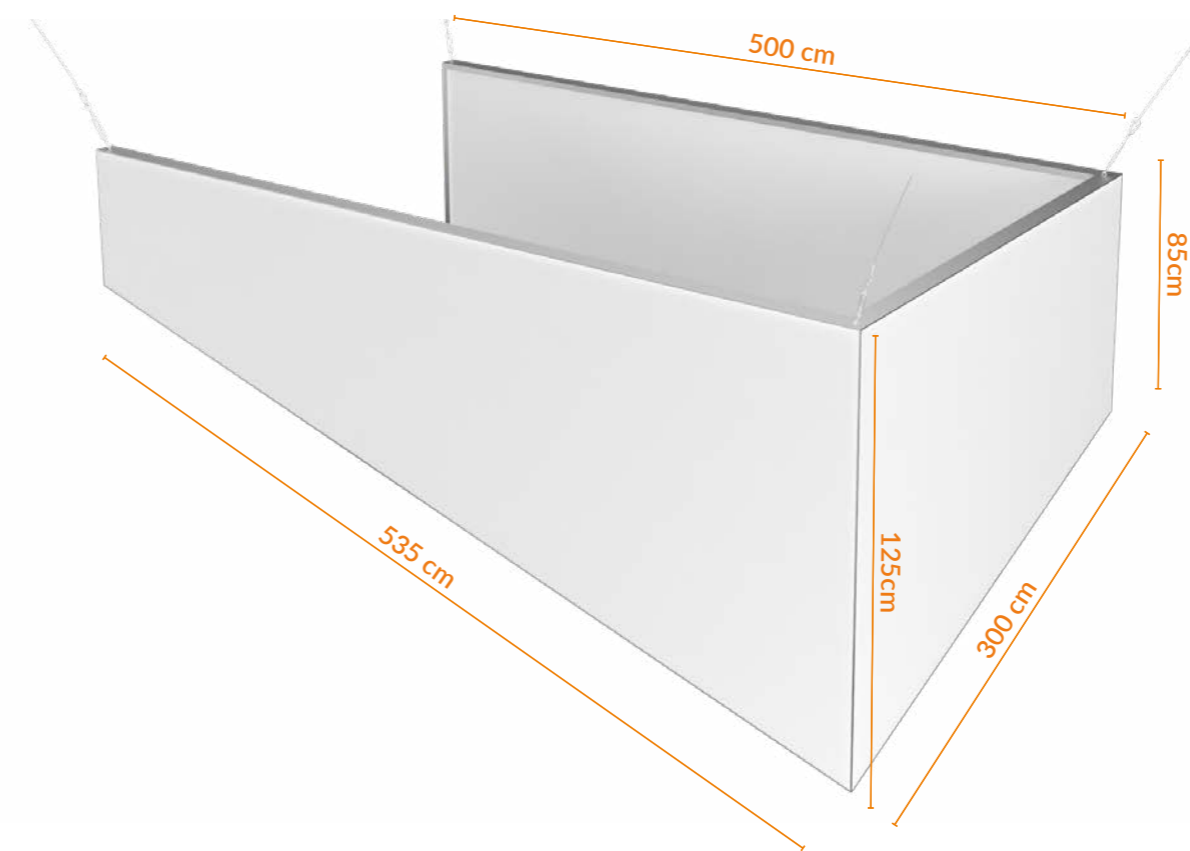

 **Shape: TYPE „CUSTOM“**

 **Quick installation**

The textile 3x5 ZEN CUSTOM suspension system complements our offer for exhibitors and organisers of events, galas, and conferences. By choosing the CUSTOM version, you are guaranteed that the size and shape of the system will fulfil your expectations. The Zen system is made of high quality aluminium alloys. The systems are light, which makes them easy to suspend from load bearing structures.



Information

System dimensions from visualization [cm]
300x500x125cm
Total weight [kg]
35

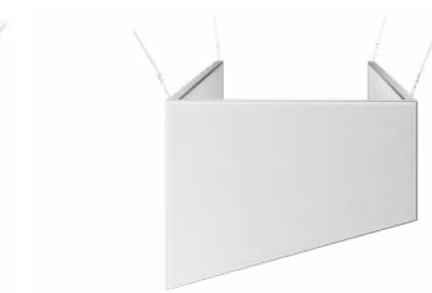

Details
Package dimensions [cm]
1x[30x30x310] + 2x[30x30x110]



Set price

Suspended systems	1pcs
interchangeable fabric with print	3pcs
fabric without print	3pcs
Metal holders	4pcs
Spring hooks	4pcs
Lines for installation (2m each)	4pcs

 **Ask your advisor**

The visualised model is priced at
1 900 GBP



Additional equipment

Need more accessories for your stall? Would you like to stand out to attract the visitors? Check out what's available in our offer. Choose from: flags, advertising cups, roll ups, countertop displays. And many more...



Application:

- Promotions in supermarkets
- Trade fair stands
- Shopping malls

Pricing

Type of stand	Stand type	Non-equipped stand
PROMO STAND	1x1 SEMI ISLAND 	412,60 GBP
PROMO STAND	1x2 SEMI ISLAND 	825,20 GBP
PROMO STAND	1x3 SEMI ISLAND 	1 237,80 GBP
PROMO STAND	1x4 SEMI ISLAND 	1 640,40 GBP
PROMO STAND	2x1 L-SHAPE ZEN 	1 234,20 GBP
PROMO STAND	2 x 2 L-SHAPE 	930,00 GBP
PROMO STAND	2x2 SEMI ISLAND 	660,00 GBP

Type of stand	Stand type	Non-equipped stand
PROMO STAND	2x2 L-SHAPE ZEN 	1 650,40 GBP
PROMO STAND	3x1 U-SHAPE ZEN 	2 405,80 GBP
EXHIBITION STAND	3x2 L-SHAPE 	1 508,20 GBP
EXHIBITION STAND	3x2 L-SHAPE A 	1 720,80 GBP
EXHIBITION STAND	3x2 U-SHAPE A 	4 012,60 GBP
PROMO STAND	3x2 L-SHAPE ZEN 	2 066,60 GBP
PROMO STAND	3x2 U-SHAPE ZEN 	4 012,60 GBP

 Packaging: textile bag + box

💰 Pricing



Type of stand	Stand type	Non-equipped stand
EXHIBITION STAND	3x3 L-SHAPE 	1 626,40 GBP
EXHIBITION STAND	3x3 SEMI ISLAND 	1 300,00 GBP
EXHIBITION STAND	3x3 SEMI ISLAND A 	1 742,60 GBP
EXHIBITION STAND	3x3 SEMI ISLAND B 	1 960,40 GBP
EXHIBITION STAND	3x3 L-SHAPE ZEN 	1 966,40 GBP
EXHIBITION STAND	3x5 SEMI ISLAND 	2 243,00 GBP
EXHIBITION STAND	3x5 SEMI ISLAND A 	3 125,00 GBP

 Packaging: textile bag + box

Type of stand	Stand type	Non-equipped stand
EXHIBITION STAND	3x5 SEMI ISLAND B 	2 525,40 GBP
EXHIBITION STAND	3x5 SEMI ISLAND C 	2 673,80 GBP
EXHIBITION STAND	3x5 LSHAPE ZEN 	5 324,00 GBP
EXHIBITION STAND	4x4 ISLAND 	1 160,00 GBP
EXHIBITION STAND	4x4 L-SHAPE 	2 592,60 GBP
EXHIBITION STAND	5x5 ISLAND ZEN 	5 732,00 GBP
EXHIBITION STAND	5x5 ISLAND ZEN A 	5 506,00 GBP

💰 Pricing

Type of stand	Stand type	Non-equipped stand
EXHIBITION STAND	6x4 L-SHAPE ZEN 	7 082,40 GBP

Type of stand	Stand type	Non-equipped stand
FURNISHINGS	3x5 ZEN 	1 640,00 GBP
FURNISHINGS	3x5 ZEN CUSTOM 	1 900,00 GBP

 **Additional equipment**

Additional equipment
 Need more accessories for your stall?
 Would you like to stand out to attract the visitors? Check out what's available in our offer.
 Choose from: flags, advertising cups, roll ups, countertop displays. And many more...

 Packaging: textile bag + box

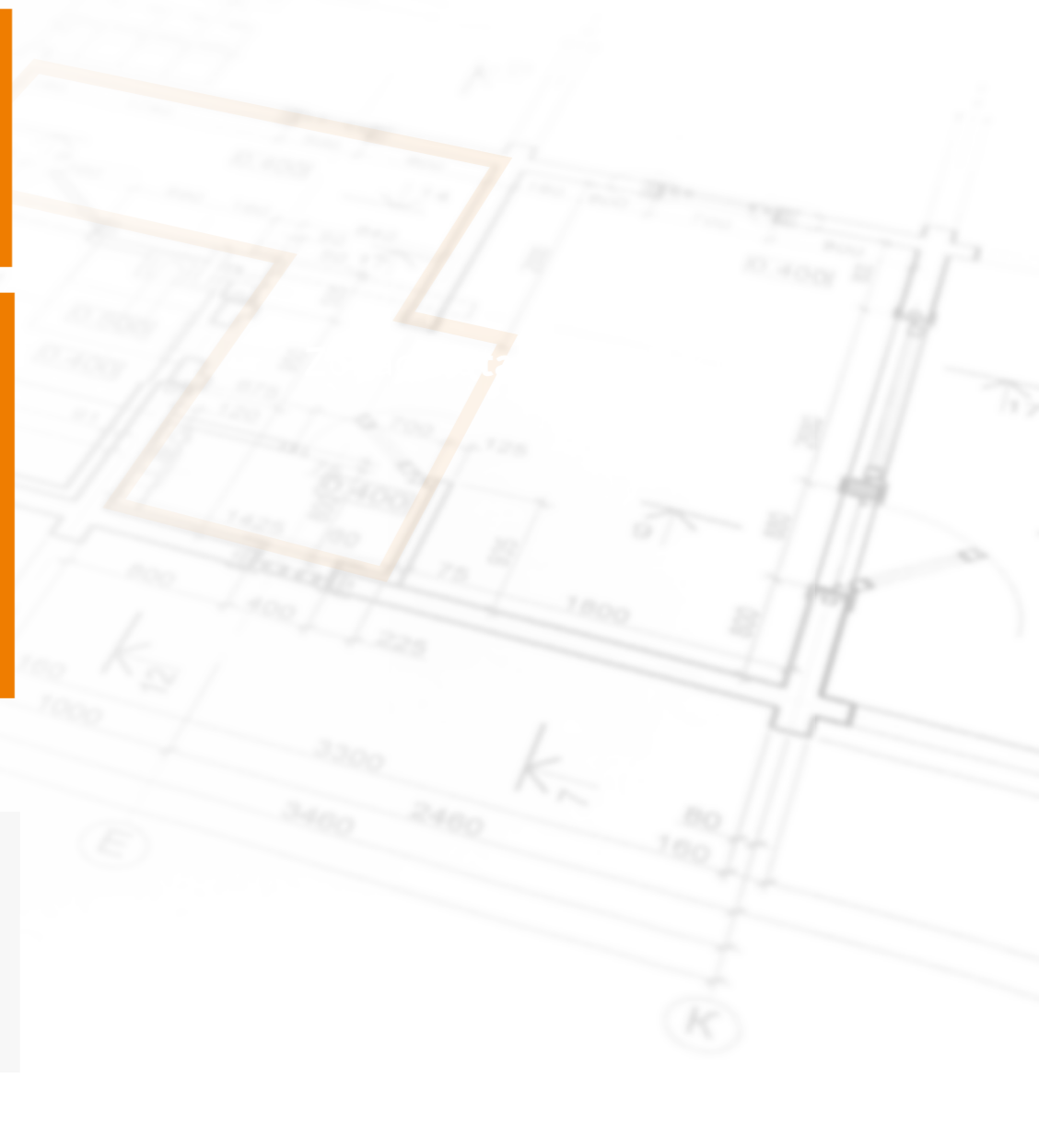

GERMANY:

+48 504 237 723
+ 48 510 925 461
de@laboprint.eu

AUSTRIA:

+48 504 237 723
+ 48 510 925 461
at@laboprint.eu

NORWAY:

+48 504 067 294
no@laboprint.eu

FRANCE:

+48 504 067 403
+ 48 516 041 030
fr@laboprint.eu

LUXEMBOURG:

+48 517 250 373 (DE)
+48 504 067 403 (FR)
lu@laboprint.eu

SWITZERLAND:

+48 504 237 723 (DE)
+48 510 925 461 (DE)
+48 504 067 403 (FR)
ch@laboprint.eu

SWEDEN:

+48 504 067 389
+48 504 067 29
se@laboprint.eu

FINLAND:

+48 504 067 294
+48 504 067 389
fi@laboprint.eu

BELGIUM:

+48 504 067 403 (FR)
+48 516 041 055 (NL)
be@laboprint.eu

POLAND:

+48 510 925 460
+ 48 506 742 763
pl@laboprint.eu

IRELAND:

+48 510 925 418
+48 572 698 260
irl@laboprint.eu

UNITED KINGDOM

+48 510 925 418
+48 572 698 260
en@laboprint.eu

DENMARK:

+48 504 067 294
dk@laboprint.eu

ITALY:

+48 453 071 283
it@laboprint.eu

NETHERLANDS:

+48 516 041 055
nl@laboprint.eu

www.laboprint.eu

LABO PRINT
EXPO
Best fairs way!

www.laboprint.eu