

 LaboPrint

EXPO

Best fairs way!



Exhibition stands

Promo stands

Suspended systems

Types of stands

Need a non-standard arrangement?

Send us a message!

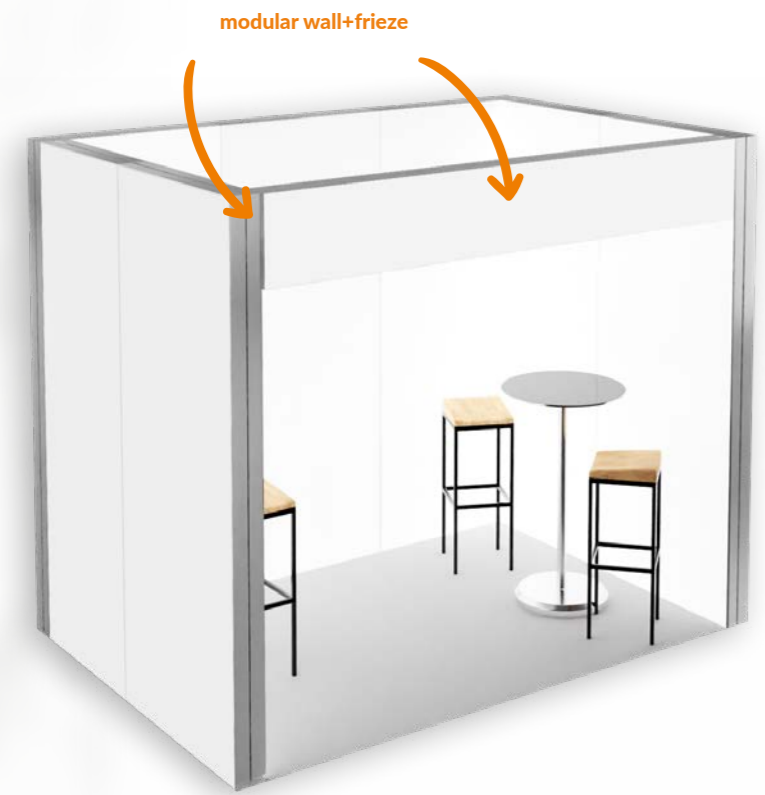

Open from two sides (L-SHAPE)



Open from one side (U-SHAPE)



Open from three sides (SEMI ISLAND)



Open from all sides (ISLAND)

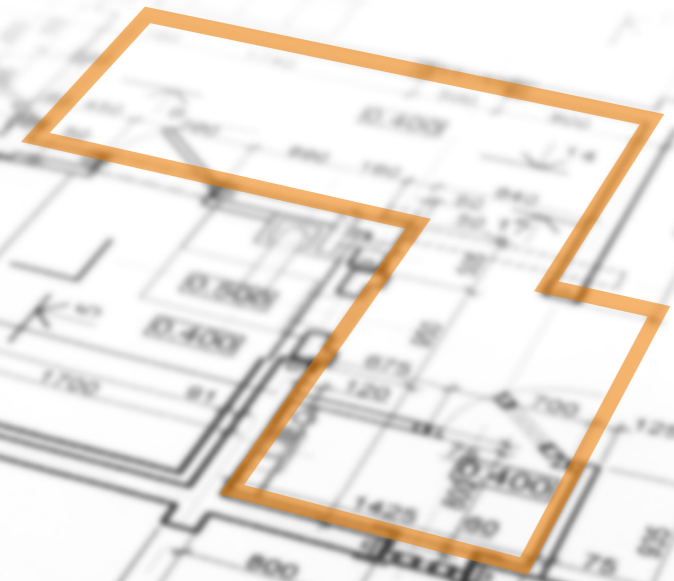

CUSTOMIZED STANDS.
Can't find a solution that meets your needs?

Send us a message!



LEGEND



PROMO STAND

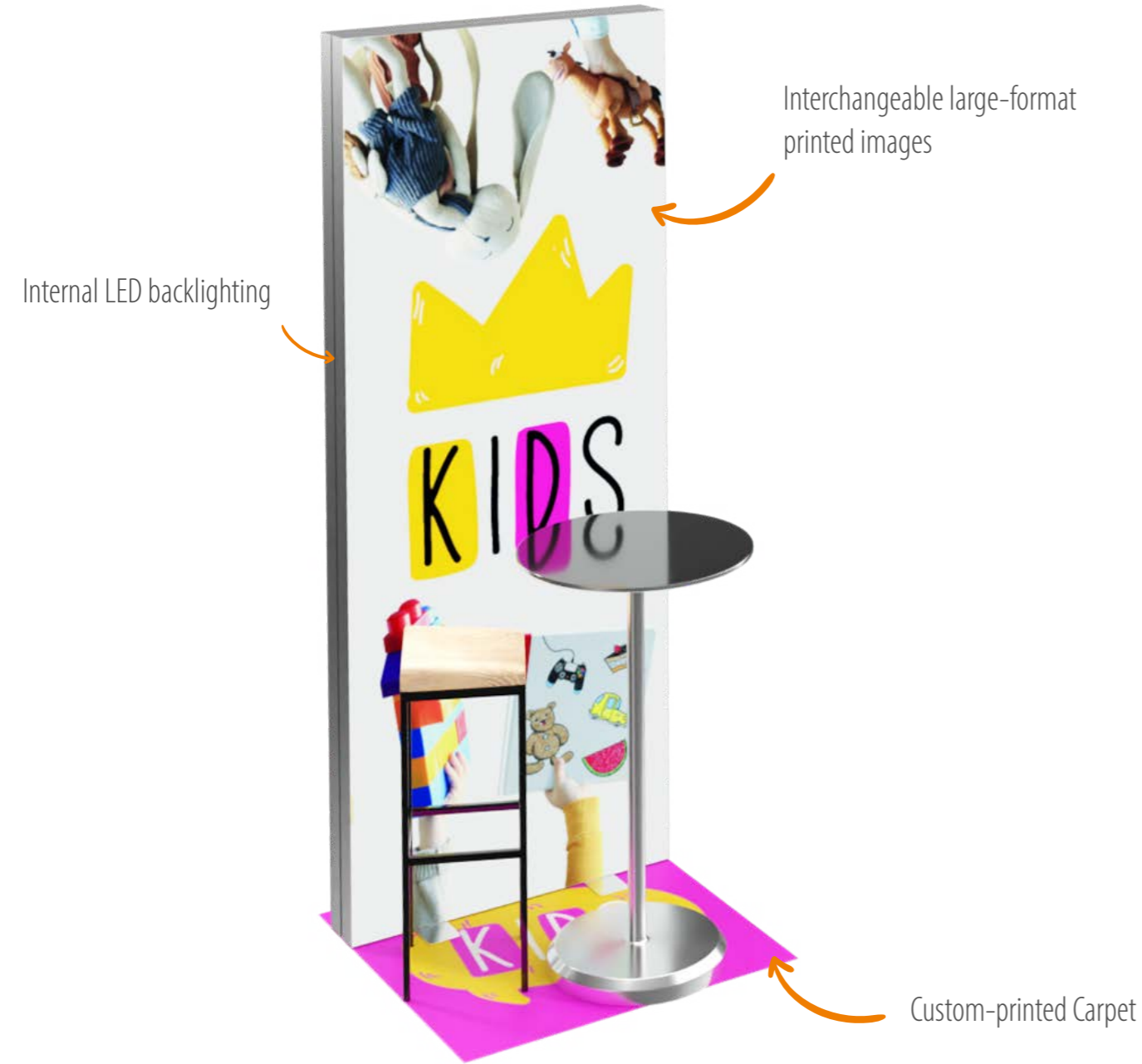

1x1 SEMI ISLAND



-  **Wall layout SEMI ISLAND**
-  **Easy Transportation**
-  **Quick installation**

The 1x1 SEMI ISLAND display stand is made of aluminium profiles for DIY assembly and carpeting with the print of your choice. Thanks to their small size, the packed elements of the stand will fit in your car. This is an excellent solution for all kinds of promotional or testing sessions in shopping centres. Comes with all elements required for assembly and an instruction manual.



Information

Promo Stand [cm]
100x100x250
Total weight [kg]
13



Details

Package dimensions [cm]
1x[255x20x15] + 1x[105x25x25]



Non-equipped stand

| | |
|-----------------------------------|------|
| modular wall | 1pcs |
| interchangeable fabric with print | 1pcs |
| fitted carpet with print | 1pcs |

480 EUR



Additional equipment

Ask your advisor about tables, counters, chairs, flyer displays, extension cords or additional lighting. We also offer a range of accessories - advertising cups, flags, rollups, stands, displays and much more.

Write to us - we are at your service!

PROMO STAND

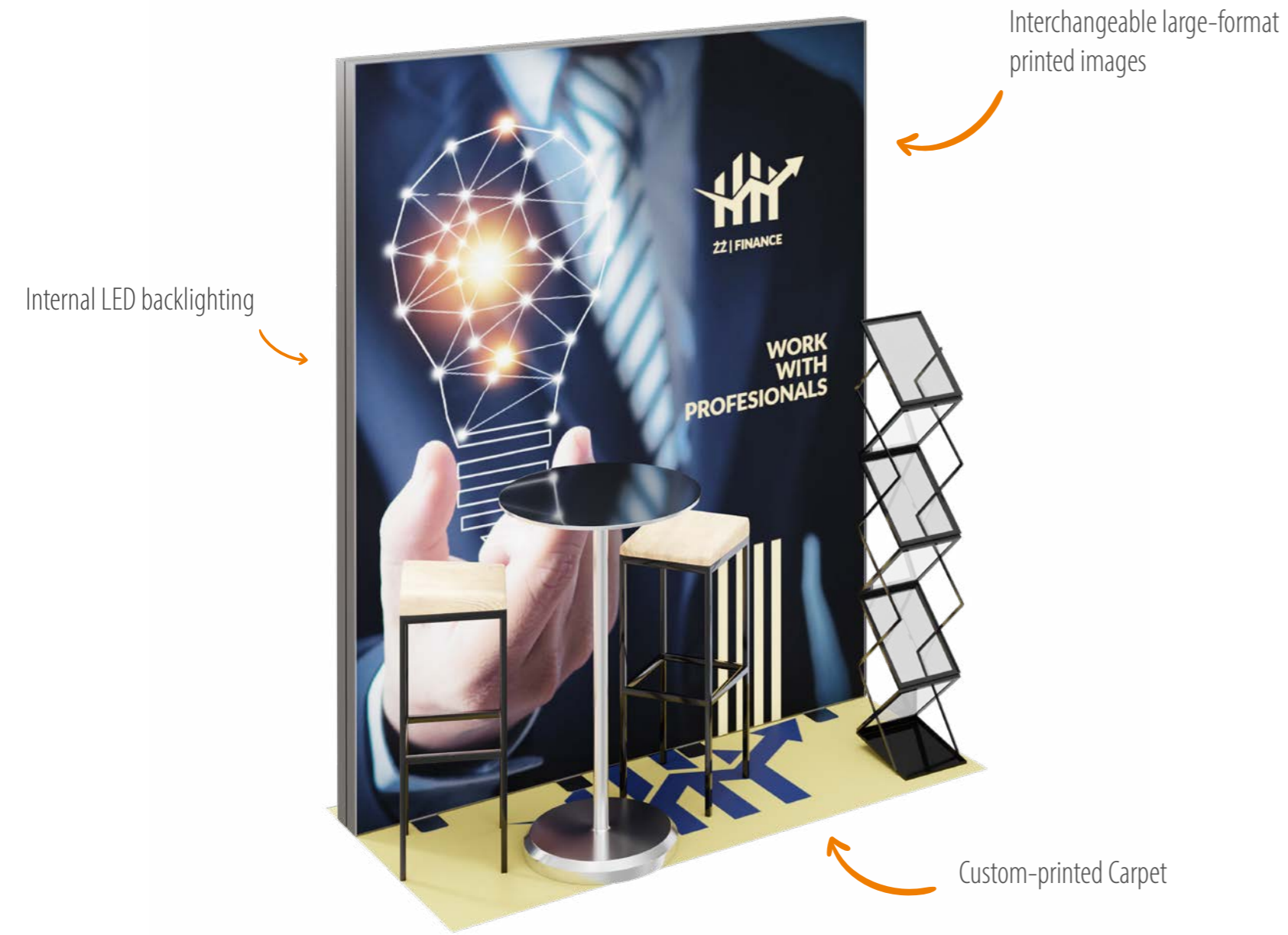

1x2 SEMI ISLAND

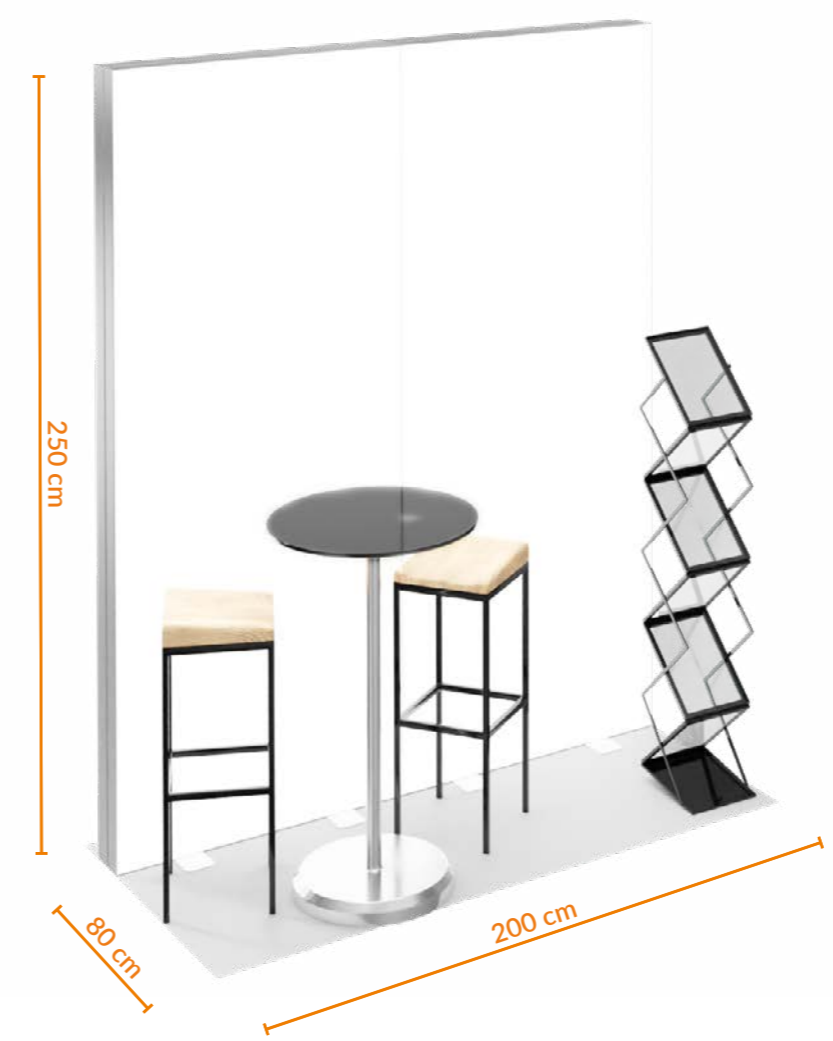

-  **Wall layout SEMI ISLAND**
-  **Easy Transportation**
-  **Quick installation**

The 1x2 SEMI ISLAND display stand is made of aluminium profiles for DIY assembly and carpeting with the print of your choice. The stand is small and easy to assemble. Will hold two chairs, a table, and a flyer holder. Comes with all elements required for assembly and an instruction manual.

 **Information**

Promo Stand [cm]
100x200x250

Total weight [kg]
26

Details

Package dimensions [cm]
2x[255x20x15] + 1x[105x25x25]



 **Non-equipped stand**

| | |
|-----------------------------------|------|
| modular wall | 2pcs |
| interchangeable fabric with print | 1pcs |
| fitted carpet with print | 1pcs |

 **960 EUR**

 **Additional equipment**

Ask your advisor about tables, counters, chairs, flyer displays, extension cords or additional lighting. We also offer a range of accessories - advertising cups, flags, rollups, stands, displays and much more.

Write to us - we are at your service!

PROMO STAND

Interchangeable large-format printed images

Internal LED backlighting



Custom-printed Carpet

1x3 SEMI ISLAND

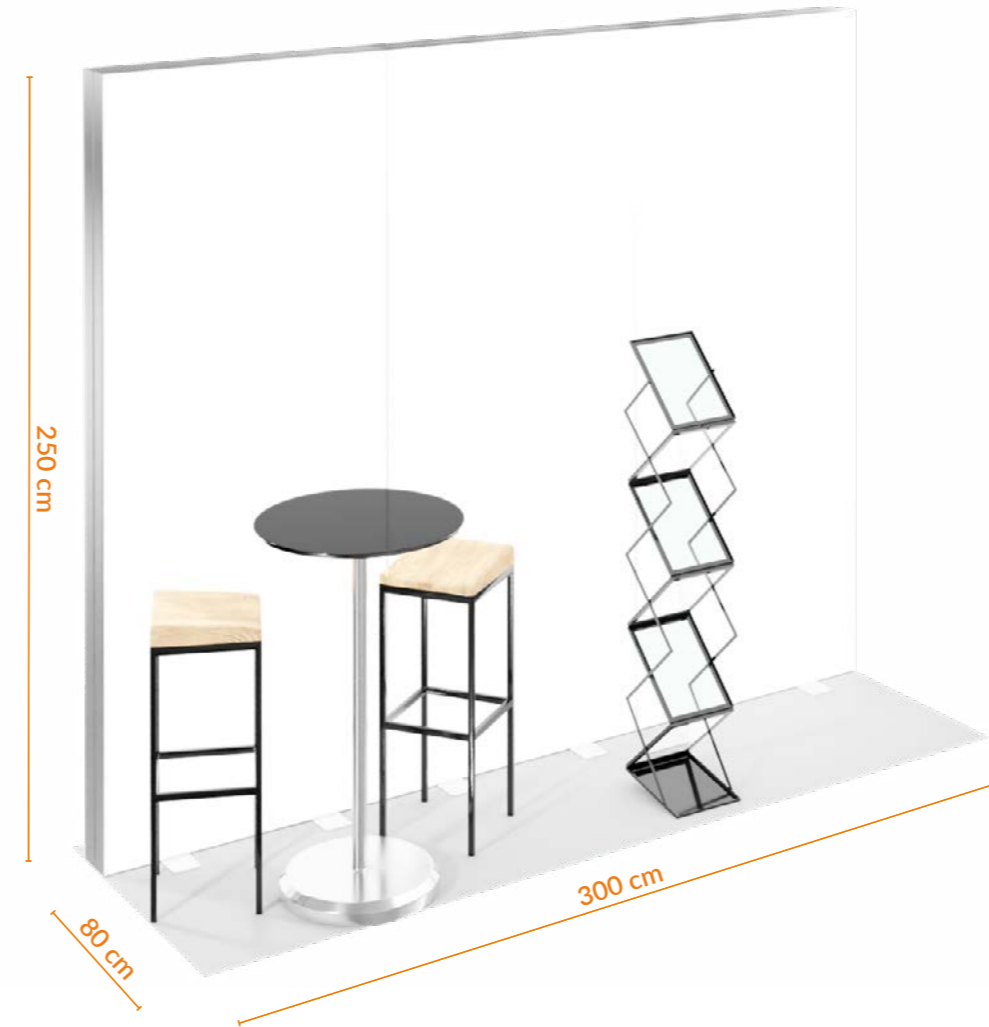

-  **Wall layout SEMI ISLAND**
-  **Easy Transportation**
-  **Quick installation**

The 1x3 SEMI ISLAND display stand is made of aluminium profiles for DIY assembly and carpeting with the print of your choice. The 3 x 2,5 m backlit wall supports large graphics display. Thanks to their small size, the packed elements of the stand will fit in your car. Comes with all elements required for assembly and an instruction manual.



Information

Promo Stand [cm]
100x300x250
Total weight [kg]
39



Details

Package dimensions [cm]
3x[255x20x15] + 1x[105x25x25]



Non-equipped stand

| | |
|-----------------------------------|------|
| modular wall | 3pcs |
| interchangeable fabric with print | 1pcs |
| fitted carpet with print | 1pcs |

1 439 EUR



Additional equipment

Ask your advisor about tables, counters, chairs, flyer displays, extension cords or additional lighting. We also offer a range of accessories - advertising cups, flags, rollups, stands, displays and much more.

Write to us - we are at your service!

PROMO STAND

Interchangeable large-format printed images

Internal LED backlighting



Custom-printed Carpet

1x4 SEMI ISLAND

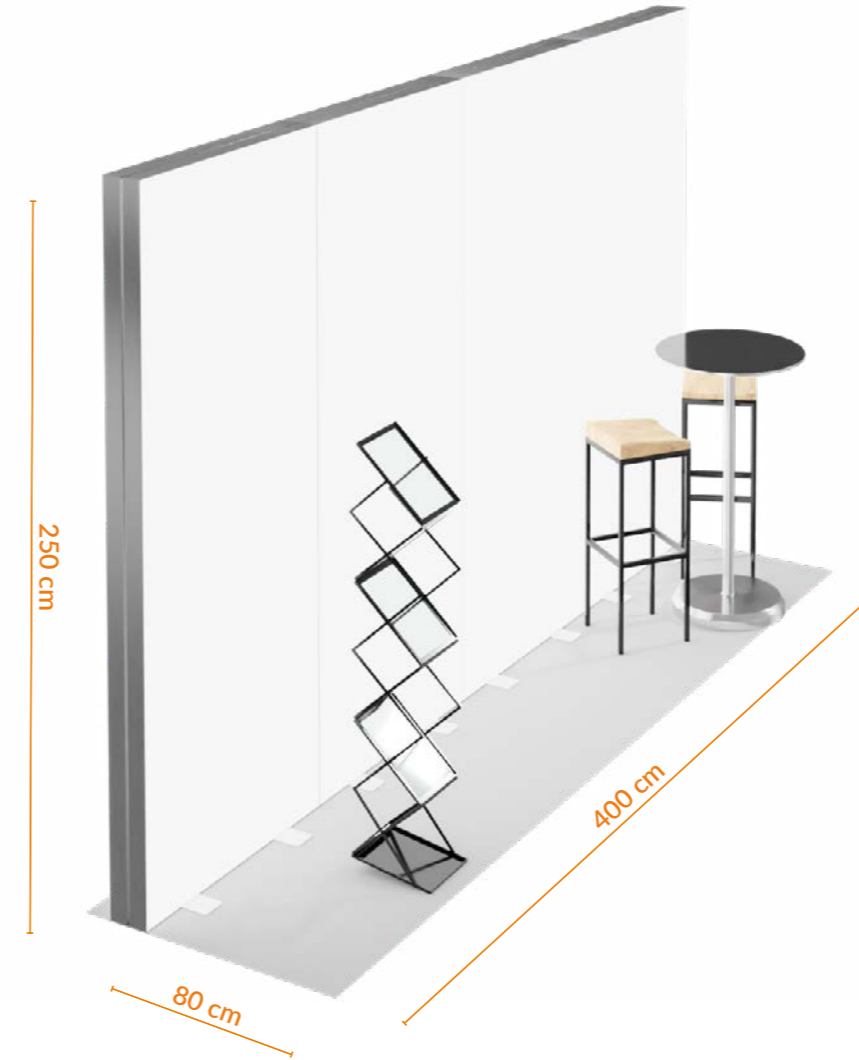

- Wall layout SEMI ISLAND
- Easy Transportation
- Quick installation

The 1x4 SEMI ISLAND display stand is made of a light aluminium structure for DIY assembly and carpeting with the print of your choice. The almost four square metres make it possible to arrange your equipment with freedom and arrange two conversation spaces. Thanks to their small size, the packed elements of the stand will fit in your car. Comes with all elements required for assembly and an instruction manual.

Information

Promo Stand [cm]
100x400x250
Total weight [kg]
52



Details
Package dimensions [cm]
4x[255x20x15] + 1x[105x25x25]

Non-equipped stand

| | |
|-----------------------------------|------|
| modular wall | 4pcs |
| interchangeable fabric with print | 1pcs |
| fitted carpet with print | 1pcs |

1 907 EUR

Additional equipment

Additional equipment

Ask your advisor about tables, counters, chairs, flyer displays, extension cords or additional lighting. We also offer a range of accessories - advertising cups, flags, rollups, stands, displays and much more.

Write to us - we are at your service!



Application:

- Islands in the galleries
- Business conferences
- Promotions in supermarkets
- Trade fair stands



PROMO STAND







Interchangeable large-format printed images

Internal LED backlighting

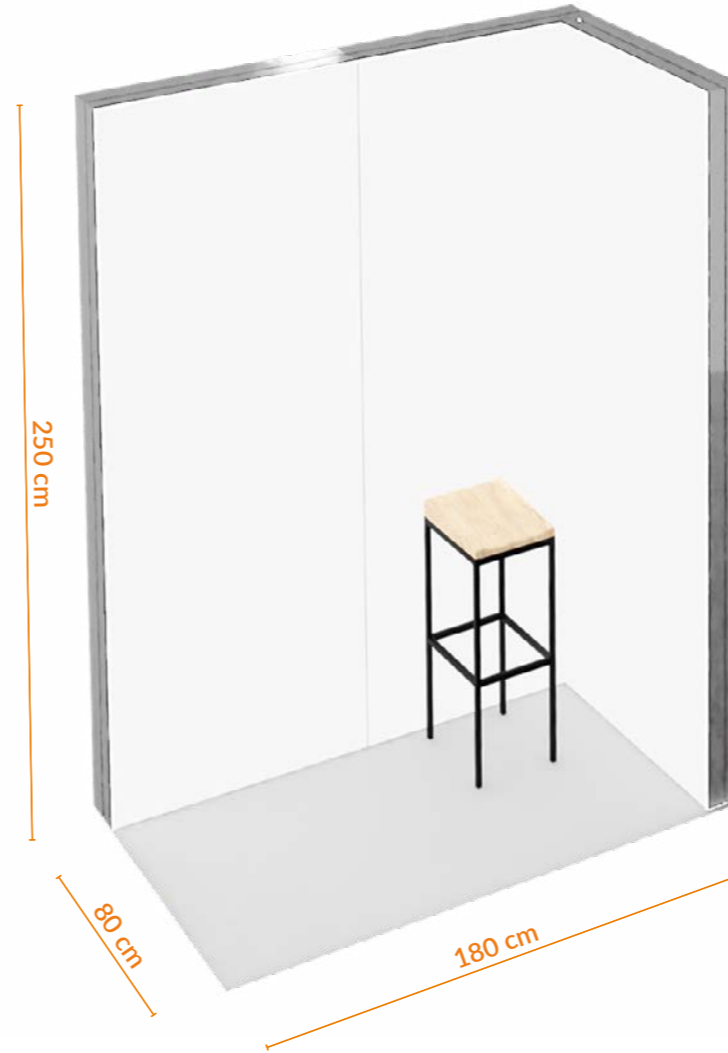
Custom-printed Carpet

2x1 L-SHAPE ZEN



-  **Wall layout L-SHAPE**
-  **Easy Transportation**
-  **Quick installation**

The 2x1 L-SHAPE ZEN display stand is made of aluminium profiles for DIY assembly and carpeting with the print of your choice. The L-shaped frames compose two partitions with backlit graphics. The structure is perfect as a mini island in shopping centres or for promotional purposes. Thanks to their small size, the packed elements of the stand will fit in your car. Comes with all elements required for assembly and an instruction manual.



Information

Promo Stand [cm]
200x100x250
Total weight [kg]
38



Details

Package dimensions [cm]
3x[255x20x15] + 1x[105x25x25]



Non-equipped stand

| | |
|-----------------------------------|------|
| modular wall | 3pcs |
| interchangeable fabric with print | 2pcs |
| fitted carpet with print | 1pcs |

1 435 EUR



Additional equipment

Ask your advisor about tables, counters, chairs, flyer displays, extension cords or additional lighting. We also offer a range of accessories - advertising cups, flags, rollups, stands, displays and much more.



Write to us - we are at your service!

PROMO STAND

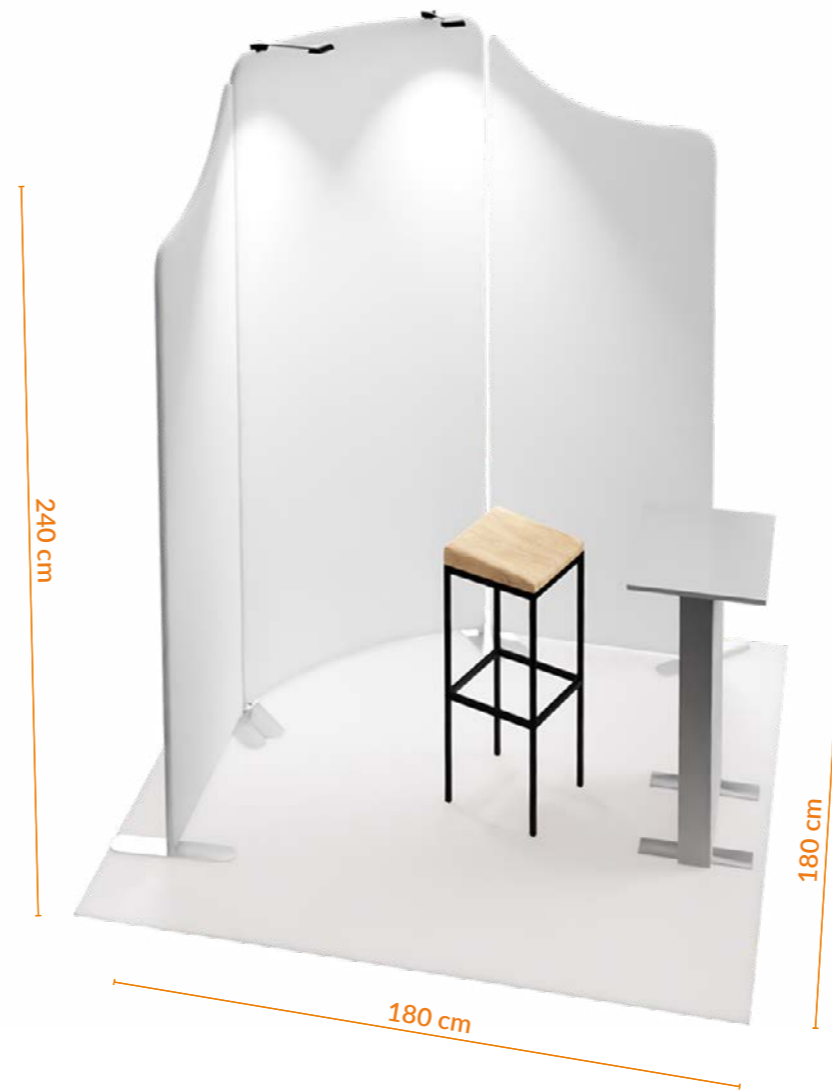

2x2 L-SHAPE



-  **Wall layout L-SHAPE**
-  **Easy Transportation**
-  **Quick installation**

The 2x2 L-SHAPE display stand is made of a light aluminium structure, which is assembled with strong magnets. Comes with carpeting with the print of your choice. The structure is foldable and fits in the dedicated bag for much easier transport. Comes with all elements required for assembly and an instruction manual.



Information

Promo Stand [cm]
200x200x240
Total weight [kg]
29



Details

Package dimensions [cm]
3x[25x103x13] + 1x[105x25x25]



Non-equipped stand

| | |
|-----------------------------------|------|
| modular wall | 3pcs |
| interchangeable fabric with print | 3pcs |
| fitted carpet with print | 1pcs |

1 081 EUR



Additional equipment

Ask your advisor about tables, counters, chairs, flyer displays, extension cords or additional lighting. We also offer a range of accessories - advertising cups, flags, rollups, stands, displays and much more.

Write to us - we are at your service!

PROMO STAND



2x2 SEMI ISLAND

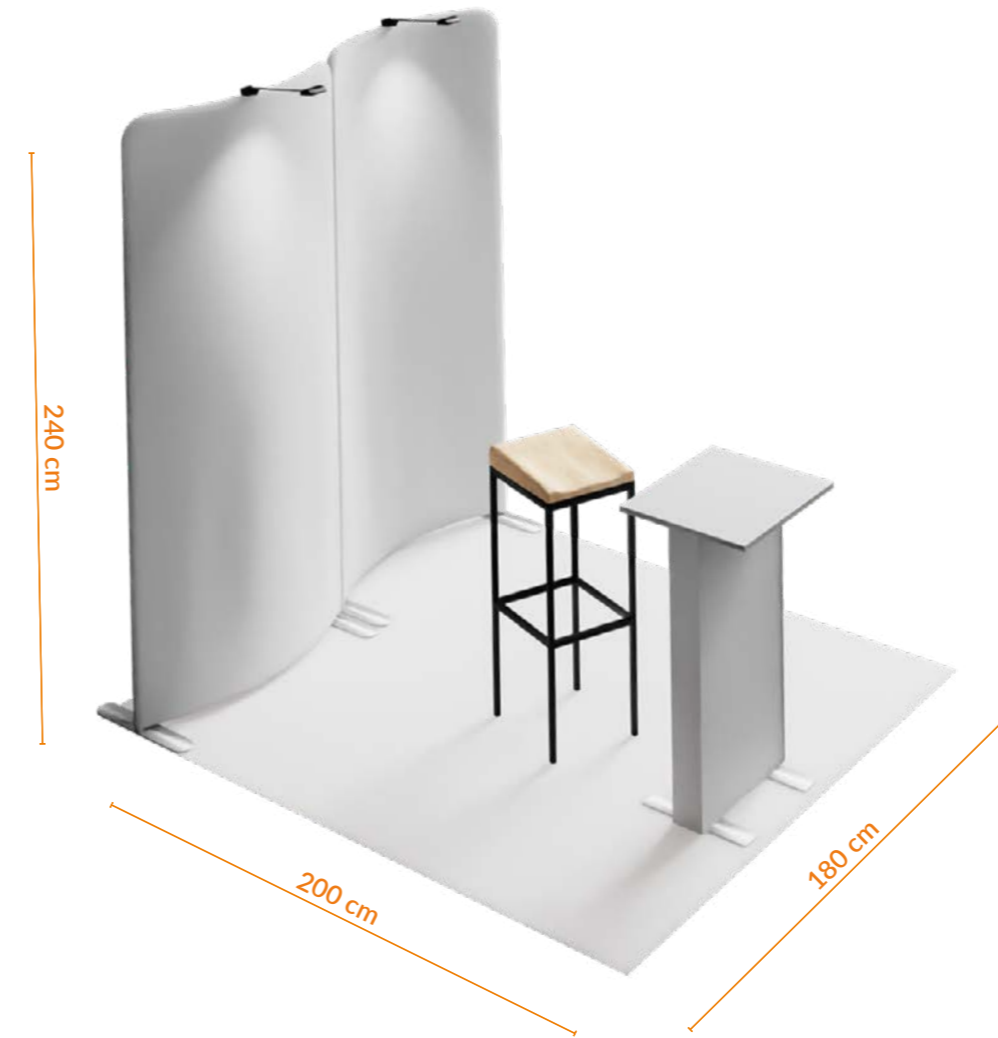

-  **Wall layout SEMI ISLAND**
-  **Easy Transportation**
-  **Quick installation**

The 2x2 SEMI ISLAND display stand is made of a light aluminium structure, which is assembled with strong magnets. Comes with carpeting with the print of your choice. The two stable backlit walls are perfect to display your graphics. The structure is foldable and fits in the dedicated bag for much easier transport. Comes with all elements required for assembly and an instruction manual.



Information

Promo Stand [cm]
200x200x240
Total weight [kg]
20



Details

Package dimensions [cm]
2x[25x103x13] + 1x[105x25x25]



Non-equipped stand

| | |
|-----------------------------------|------|
| modular wall | 2pcs |
| interchangeable fabric with print | 2pcs |
| fitted carpet with print | 1pcs |

767 EUR



Additional equipment

Ask your advisor about tables, counters, chairs, flyer displays, extension cords or additional lighting. We also offer a range of accessories - advertising cups, flags, rollups, stands, displays and much more.

Write to us - we are at your service!

PROMO STAND

Interchangeable large-format printed images



Internal LED backlighting

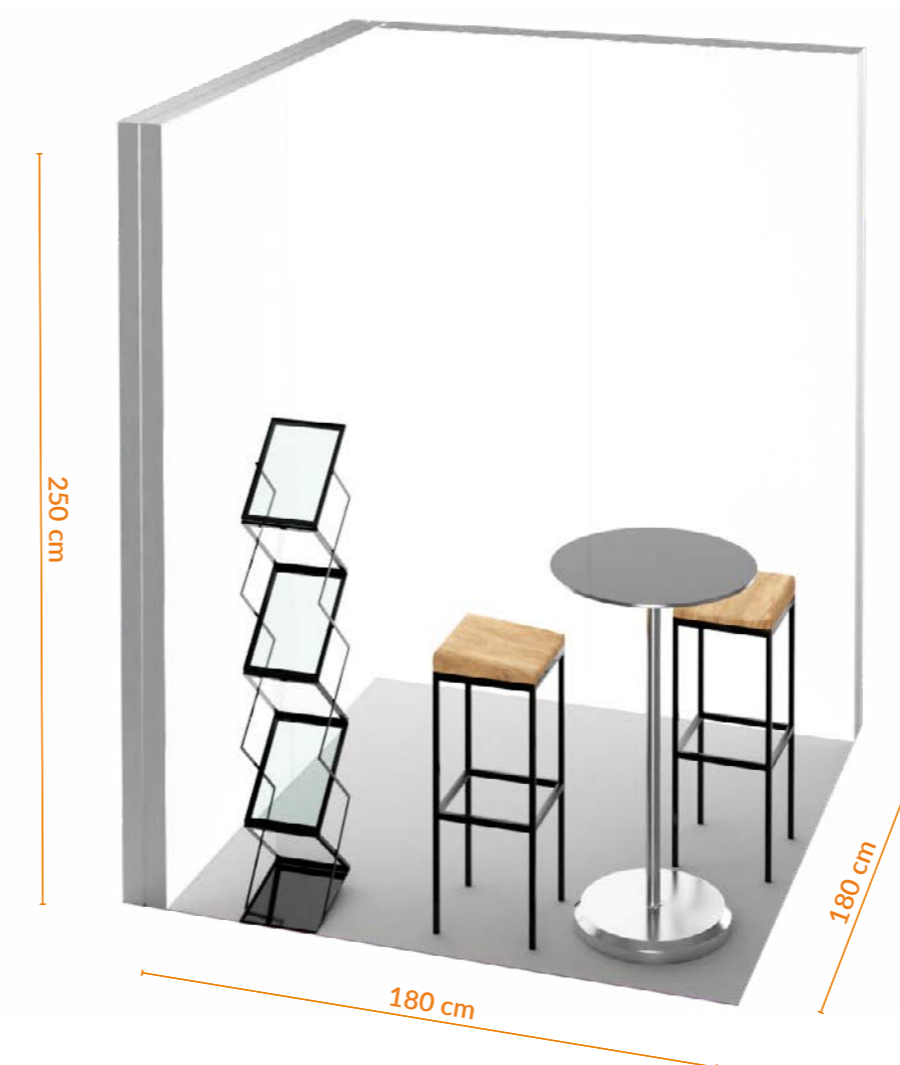

Custom-printed Carpet

2x2 L-SHAPE ZEN



-  **Wall layout L-SHAPE**
-  **Easy Transportation**
-  **Quick installation**

The 2x2 L-SHAPE ZEN display stand is made of aluminium profiles for DIY assembly and carpeting with the print of your choice. The two backlit L-shaped partitions will create comfortable space to talk with your clients. Thanks to their small size, the packed elements of the stand will fit in your car. Comes with all elements required for assembly and an instruction manual.

Information

Promo Stand [cm]
200x200x250
Total weight [kg]
52



Details
Package dimensions [cm]
4x[255x20x15] + 1x[105x25x25]

Non-equipped stand

| | |
|-----------------------------------|------|
| modular wall | 4pcs |
| interchangeable fabric with print | 2pcs |
| fitted carpet with print | 1pcs |

1 919 EUR

Additional equipment

Additional equipment

Ask your advisor about tables, counters, chairs, flyer displays, extension cords or additional lighting. We also offer a range of accessories - advertising cups, flags, rollups, stands, displays and much more.

Write to us - we are at your service!

PROMO STAND



3x1 U-SHAPE ZEN

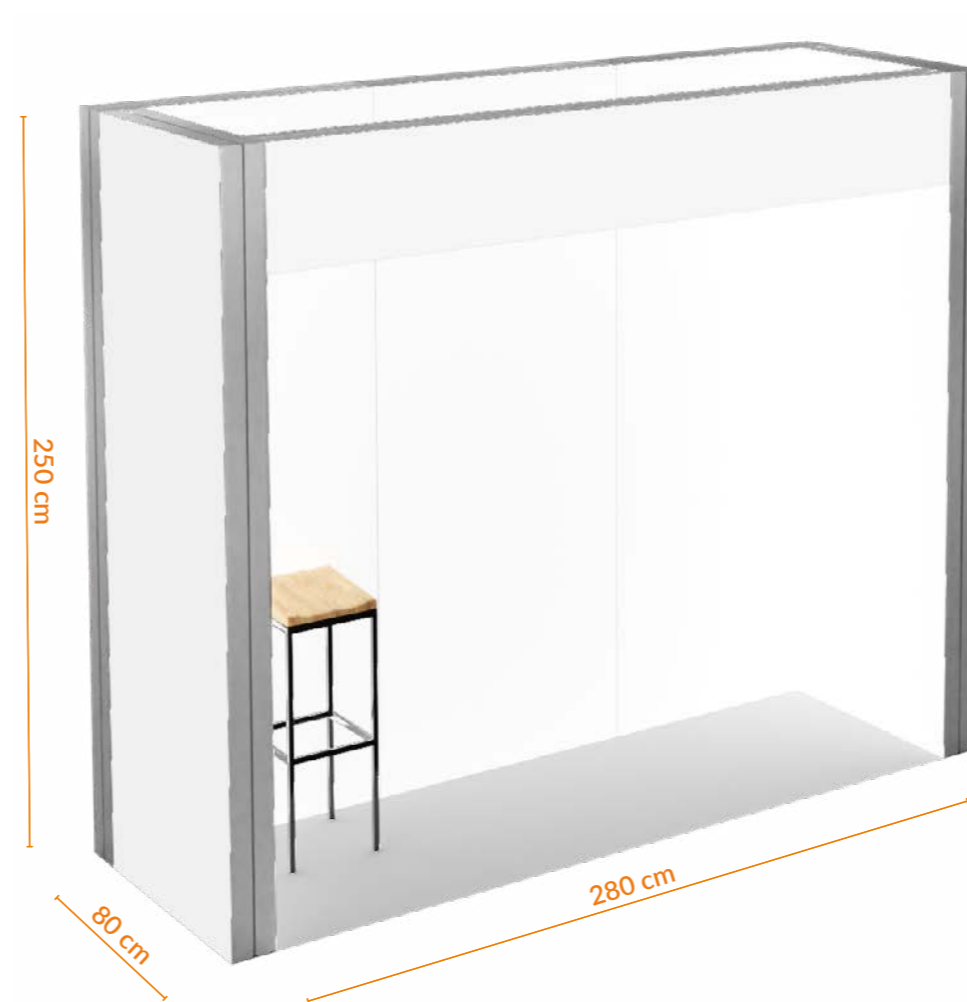

- Wall layout U-SHAPE
- Quick installation

The 3X1 U-SHAPE ZEN display stand is made of aluminium profiles for DIY assembly and carpeting with the print of your choice. This is an excellent choice for small exhibition or promotional spaces. The overhead section of the structure provides additional space for display of graphics. Thanks to their small size, the packed elements of the stand are easy to transport. Comes with all elements required for assembly and an instruction manual.

Information

Promo Stand [cm]
300x100x250
Total weight [kg]
87



Details
Package dimensions [cm]
5x[255x20x15] + 1x[105x25x25]

Non-equipped stand

| | |
|-----------------------------------|--------|
| modular wall+frieze | 5+1pcs |
| interchangeable fabric with print | 4pcs |
| fitted carpet with print | 1pcs |

2 797 EUR

Additional equipment

Ask your advisor about tables, counters, chairs, flyer displays, extension cords or additional lighting. We also offer a range of accessories - advertising cups, flags, rollups, stands, displays and much more.

Write to us - we are at your service!



Vegan
GREEN FOOD
www.laboprint.eu
f i y



Application:

- Islands in the galleries
- Business conferences
- Promotions in supermarkets
- Trade fair stands

EXHIBITION STAND

Interchangeable large-format printed images

LED lighting



Custom-printed Carpet

3x2 L-SHAPE

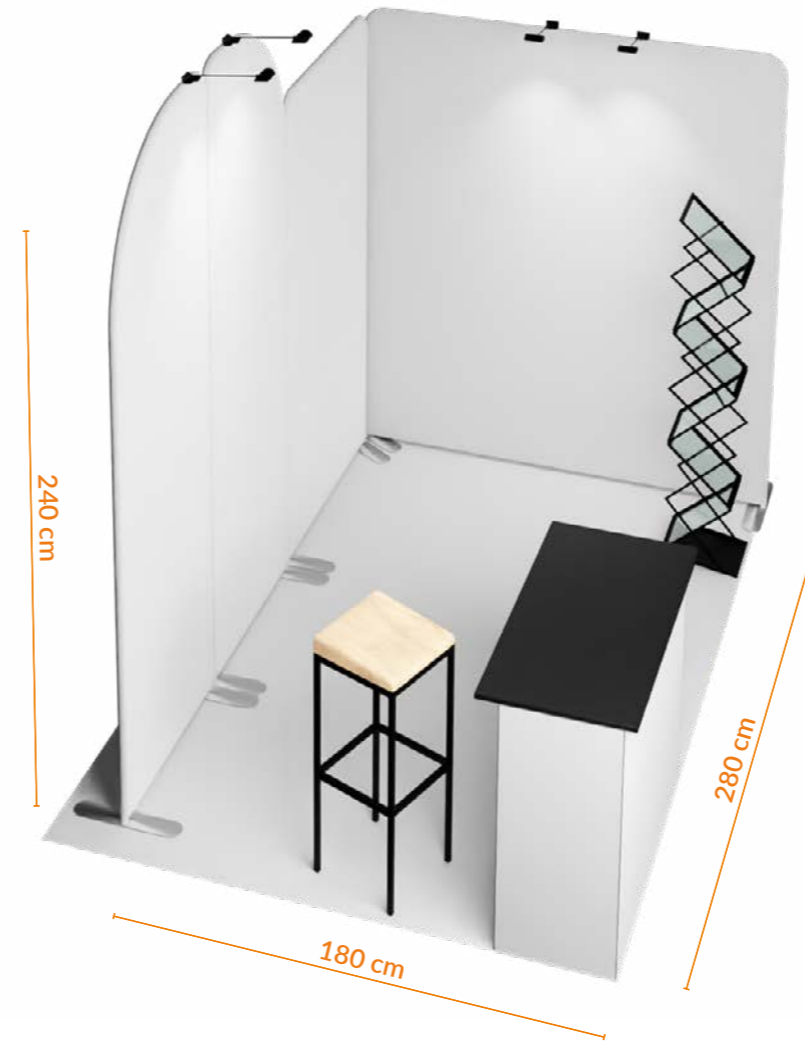

- Wall layout L-SHAPE
- Easy Transportation
- Quick installation

The 3x2 L-SHAPE exhibition stand is made of a light aluminium structure, which is assembled with strong magnets. Comes with carpeting with the print of your choice. The irregular shapes of the backlit frames allow for creative graphics designs. The structure is foldable and fits in the dedicated bags for much easier transport. Comes with all elements required for assembly and an instruction manual.

Information



Exhibition Stand [cm]
300x200x240
Total weight [kg]
49

Details

Package dimensions [cm]
4x[25x103x13] + 1x[105x25x25]

Non-equipped stand

| | |
|-----------------------------------|------|
| modular wall | 4pcs |
| interchangeable fabric with print | 4pcs |
| fitted carpet with print | 1pcs |

1 754 EUR

Additional equipment

Additional equipment

Ask your advisor about tables, counters, chairs, flyer displays, extension cords or additional lighting. We also offer a range of accessories - advertising cups, flags, rollups, stands, displays and much more.

Write to us - we are at your service!

EXHIBITION STAND



3x2 L-SHAPE A

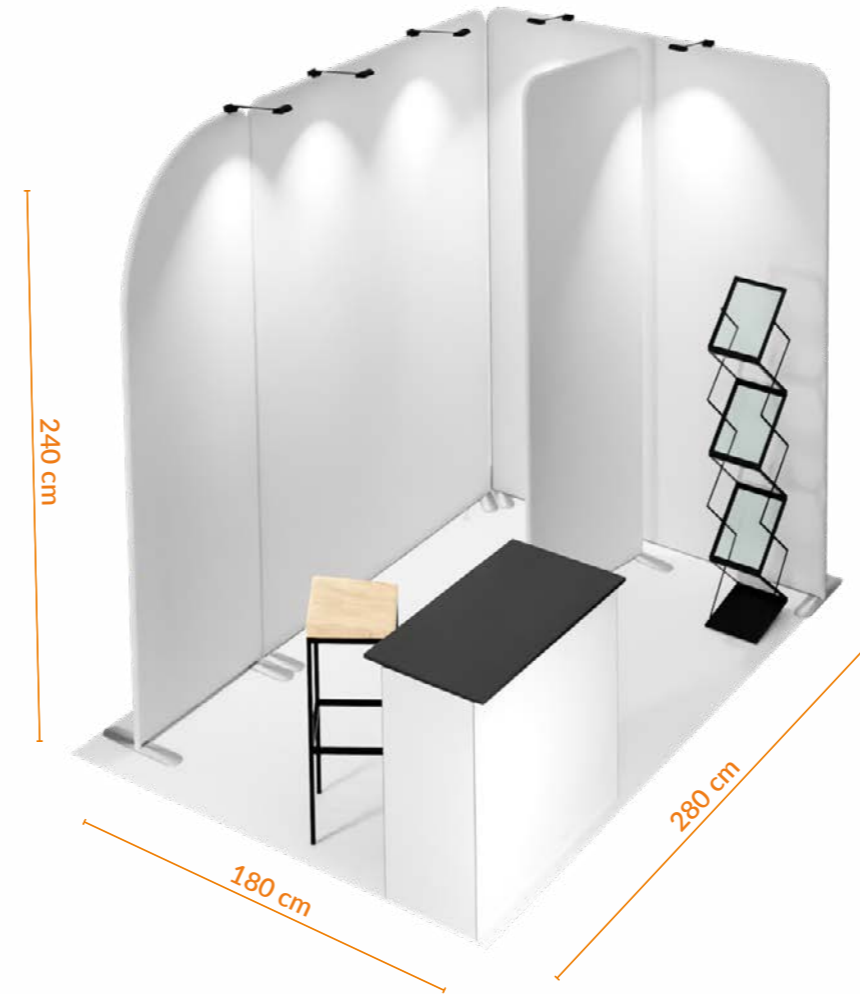

Information

Exhibition Stand [cm]
300x200x240
Total weight [kg]
44



Details

Package dimensions [cm]
5x[25x103x13] + 1x[105x25x25]



Non-equipped stand

| | |
|-----------------------------------|------|
| modular wall | 5pcs |
| interchangeable fabric with print | 5pcs |
| fitted carpet with print | 1pcs |

2 001 EUR



Additional equipment

Ask your advisor about tables, counters, chairs, flyer displays, extension cords or additional lighting. We also offer a range of accessories - advertising cups, flags, rollups, stands, displays and much more.

Write to us - we are at your service!

- Wall layout L-SHAPE**
- Easy Transportation**
- Quick installation**

The 3x2 L-SHAPE A exhibition stand is made of a light aluminium structure, which is assembled with strong magnets. Comes with carpeting with the print of your choice. The stand has the same area, but a different shape than the traditional "L". The additional partition will form a small back section. The structure is foldable and fits in the dedicated bags for much easier transport. Comes with all elements required for assembly and an instruction manual.

EXHIBITION STAND



3x2 U-SHAPE A

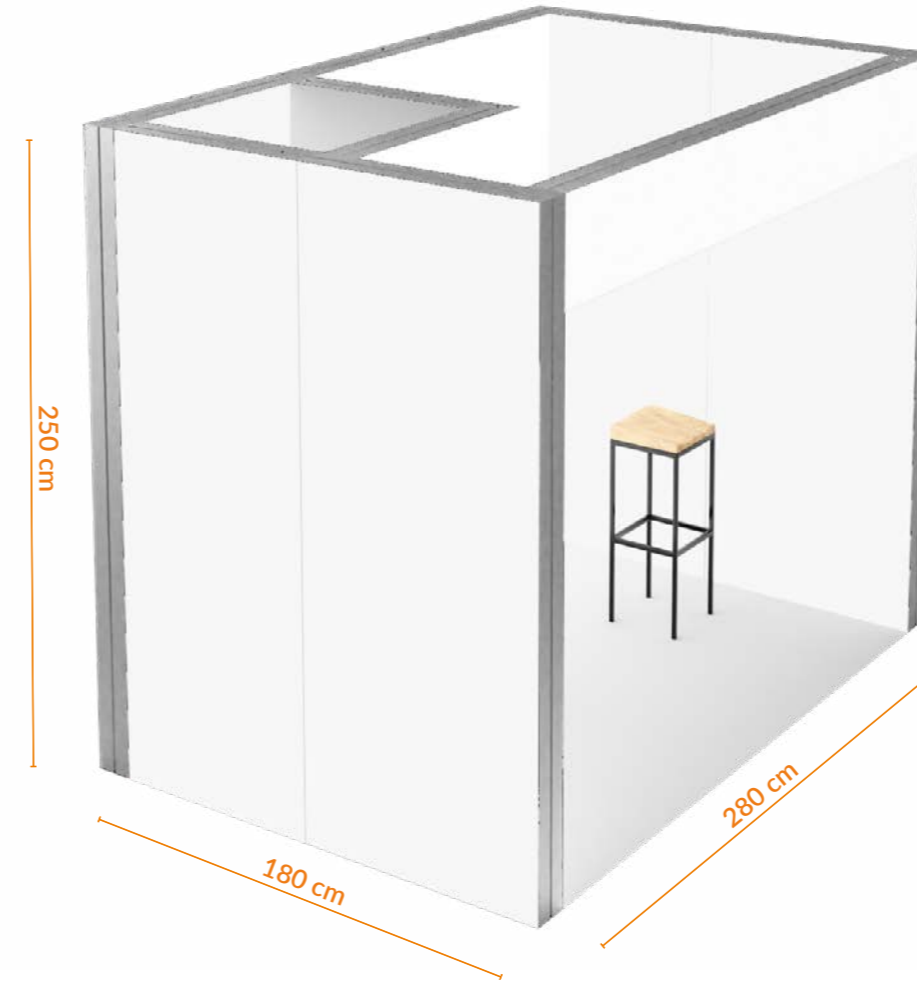

- Wall layout U-SHAPE
- Quick installation

The 3x2 U-SHAPE A exhibition stand is made of aluminium profiles for DIY assembly and carpeting with the print of your choice. As it has three walls and an overhead segment, it is a popular choice in exhibition traffic routes. Comes with all elements required for assembly and an instruction manual.

Information

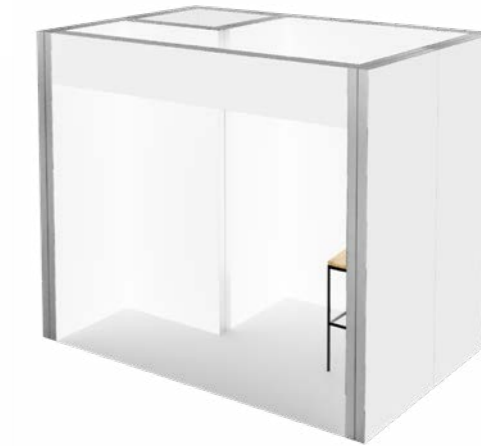

Exhibition Stand [cm]
300x200x250
Total weight [kg]
170

Details

Package dimensions [cm]
9x[255x20x15] + 1x[105x25x25]

Non-equipped stand

| | |
|-----------------------------------|--------|
| modular wall+frieze | 9+1pcs |
| interchangeable fabric with print | 6pcs |
| fitted carpet with print | 1pcs |

4 666 EUR

Additional equipment

Ask your advisor about tables, counters, chairs, flyer displays, extension cords or additional lighting. We also offer a range of accessories - advertising cups, flags, rollups, stands, displays and much more.

Write to us - we are at your service!

PROMO STAND

Internal LED backlighting



Interchangeable large-format printed images

Custom-printed Carpet

3x2 L-SHAPE ZEN

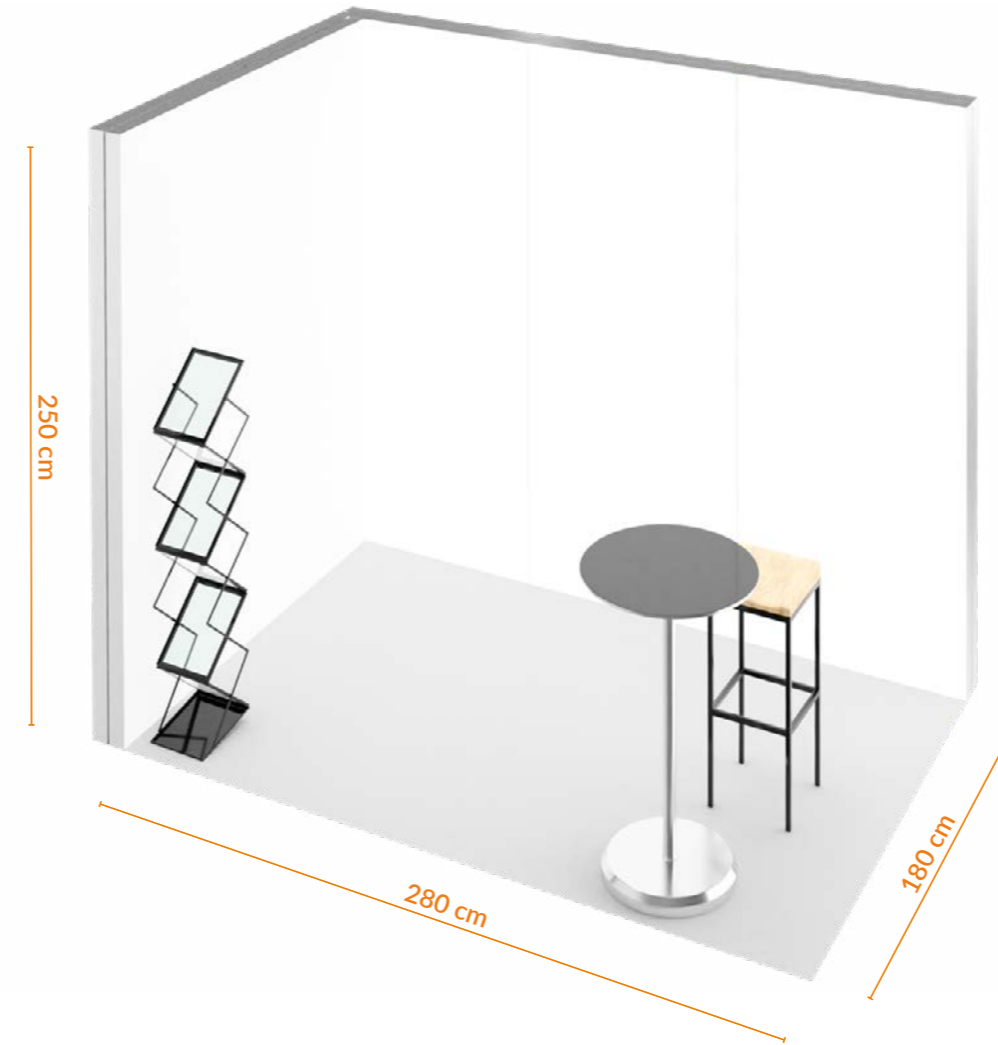

Wall layout L-SHAPE

Quick installation

The 3x2 L-SHAPE ZEN display stand is made of aluminium profiles for DIY assembly and carpeting with the print of your choice. This is a good choice for use in shopping centres or as a compact exhibition stand. Comes with all elements required for assembly and an instruction manual.

Information

Promo Stand [cm]
300x200x250
Total weight [kg]
66



Details

Package dimensions [cm]
5x[255x20x15] + 1x[105x25x25]

Non-equipped stand

| | |
|-----------------------------------|------|
| modular wall | 5pcs |
| interchangeable fabric with print | 2pcs |
| fitted carpet with print | 1pcs |

2 403 EUR

Additional equipment

Additional equipment

Ask your advisor about tables, counters, chairs, flyer displays, extension cords or additional lighting. We also offer a range of accessories - advertising cups, flags, rollups, stands, displays and much more.

Write to us - we are at your service!

PROMO STAND



3x2 U-SHAPE ZEN

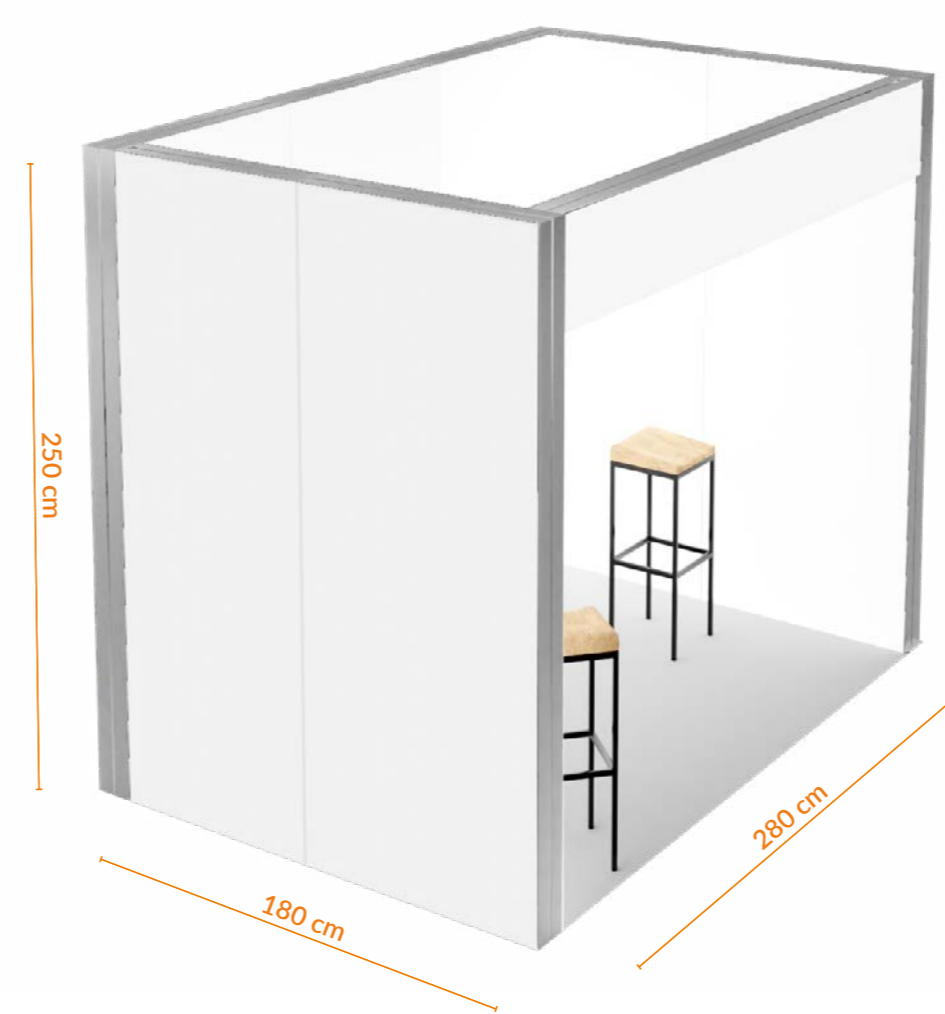

- Wall layout U-SHAPE
- Quick installation

The 3x2 U-SHAPE ZEN exhibition stand is made of aluminium profiles for DIY assembly and carpeting with the print of your choice. Contrary to the twin "A" version, it does not have a back section and offers slightly more exhibition space instead. As it has three walls and an overhead segment, it is a popular choice in exhibition traffic routes. Comes with all elements required for assembly and an instruction manual.

Information

Promo Stand [cm]
300x200x250
Total weight [kg]
132



Details
Package dimensions [cm]
7x[255x20x15] + 1x[105x25x25]

Non-equipped stand

| | |
|-----------------------------------|--------|
| modular wall+frieze | 7+1pcs |
| interchangeable fabric with print | 4pcs |
| fitted carpet with print | 1pcs |

4 665,81 EUR

Additional equipment

Ask your advisor about tables, counters, chairs, flyer displays, extension cords or additional lighting. We also offer a range of accessories - advertising cups, flags, rollups, stands, displays and much more. Write to us - we are at your service!

EXHIBITION STAND



LED lighting

Interchangeable large-format printed images

Custom-printed Carpet

The counter is also available with backlight – ask your consultant



3x3 L-SHAPE



240 cm

280 cm

280 cm

-  **Wall layout L-SHAPE**
-  **Easy Transportation**
-  **Quick installation**

The 3x3 L-SHAPE exhibition stand is made of a light aluminium structure, which is assembled with strong magnets. Comes with carpeting with the print of your choice. The almost 9 m2 offers freedom of display. The structure is foldable and fits in the dedicated bags for much easier transport. Comes with all elements required for assembly and an instruction manual.



Information

Exhibition Stand [cm]
300x300x240
Total weight [kg]
50



Details
Package dimensions [cm]
4x[25x103x13] + 1x[105x25x25]



Non-equipped stand

| | |
|-----------------------------------|------|
| modular wall | 4pcs |
| interchangeable fabric with print | 4pcs |
| fitted carpet with print | 1pcs |

1 891 EUR



Additional equipment

Ask your advisor about tables, counters, chairs, flyer displays, extension cords or additional lighting. We also offer a range of accessories - advertising cups, flags, rollups, stands, displays and much more.

Write to us - we are at your service!

EXHIBITION STAND



LED lighting

Interchangeable large-format printed images

Custom-printed Carpet

The counter is also available with backlight – ask your consultant

3x3 SEMI ISLAND

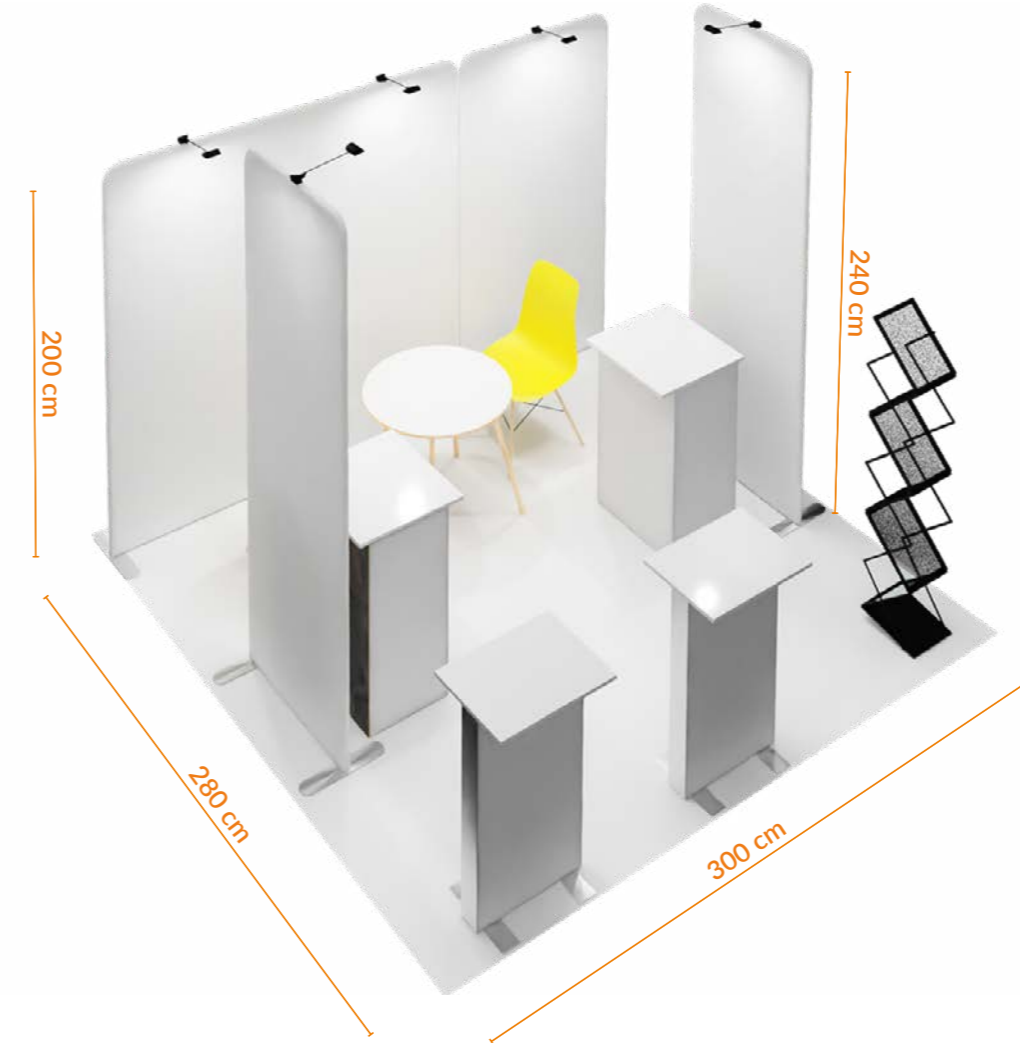

- Wall layout SEMI ISLAND
- Easy Transportation
- Quick installation

The 3x3 SEMI ISLAND exhibition stand is made of a light aluminium structure, which is assembled with strong magnets. Comes with carpeting with the print of your choice. The several partitions of different heights make it possible to arrange the space in a creative manner. The structure is foldable and fits in the dedicated bags for much easier transport. Comes with all elements required for assembly and an instruction manual.

Information

Exhibition Stand [cm]
300x300x240
Total weight [kg]
45



Details
Package dimensions [cm]
2x[25x103x13] + 2x[105x25x25]

Non-equipped stand

| | |
|-----------------------------------|------|
| modular wall | 4pcs |
| interchangeable fabric with print | 4pcs |
| fitted carpet with print | 1pcs |

1 512 EUR

Additional equipment

Additional equipment

Ask your advisor about tables, counters, chairs, flyer displays, extension cords or additional lighting. We also offer a range of accessories - advertising cups, flags, rollups, stands, displays and much more.

Write to us - we are at your service!

EXHIBITION STAND



3x3 SEMI ISLAND A



-  **Wall layout SEMI ISLAND**
-  **Easy Transportation**
-  **Quick installation**

The 3x3 SEMI ISLAND A exhibition stand is made of a light aluminium structure, which is assembled with strong magnets. Comes with carpeting with the print of your choice. The two irregularly shaped walls are attractive and encourage creative selection of the graphics. They also make up a small back section. The structure is foldable and fits in the dedicated bags for much easier transport. Comes with all elements required for assembly and an instruction manual.



Information

Exhibition Stand [cm]
300x300x240
Total weight [kg]
48



Details
Package dimensions [cm]
4x[25x103x13] + 2x[105x25x25]



Non-equipped stand

| | |
|-----------------------------------|------|
| modular wall | 4pcs |
| interchangeable fabric with print | 4pcs |
| fitted carpet with print | 1pcs |

 **2 026 EUR**



Additional equipment

Ask your advisor about tables, counters, chairs, flyer displays, extension cords or additional lighting. We also offer a range of accessories - advertising cups, flags, rollups, stands, displays and much more.

Write to us - we are at your service!

EXHIBITION STAND

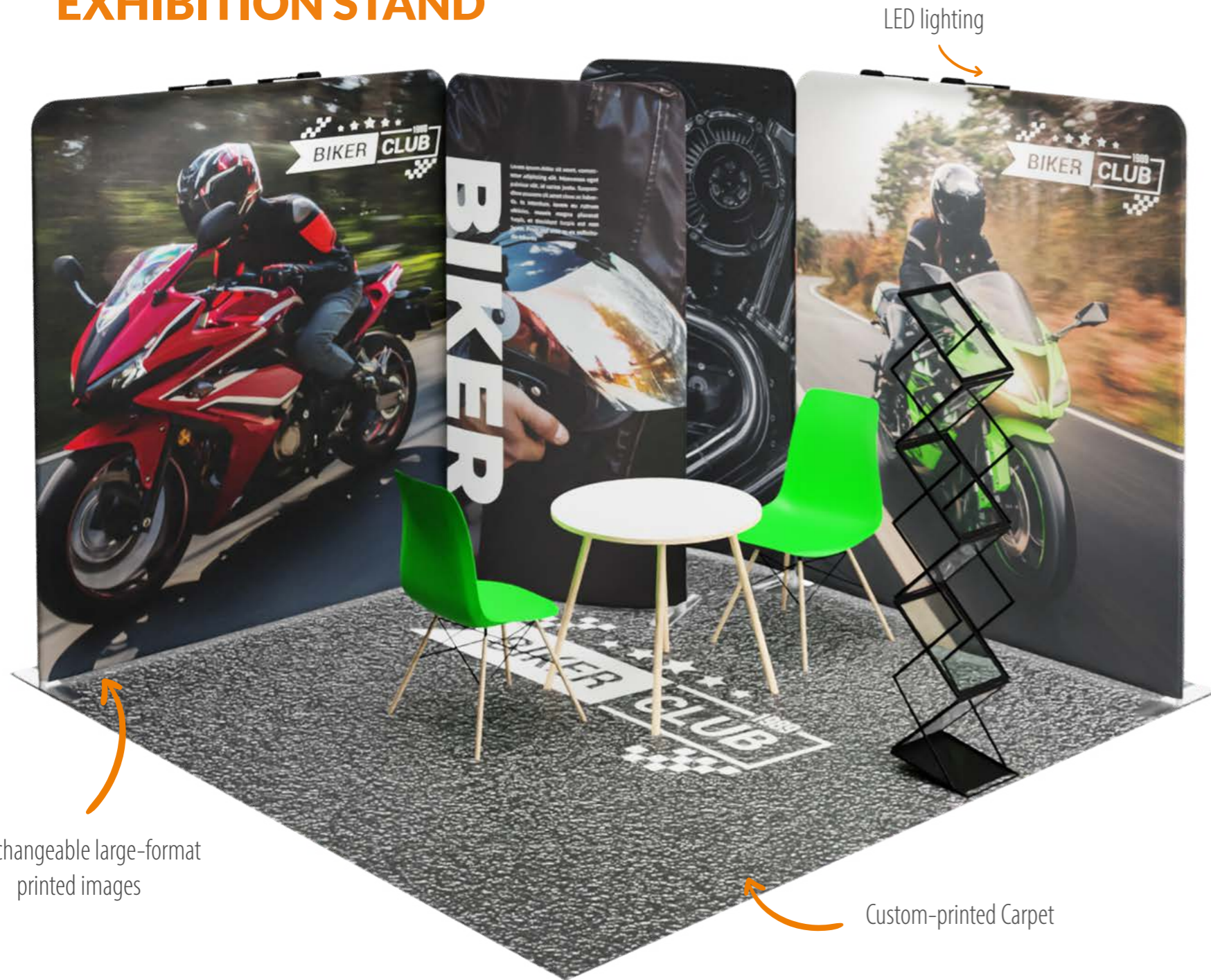

Interchangeable large-format printed images

Custom-printed Carpet

3x3 SEMI ISLAND B

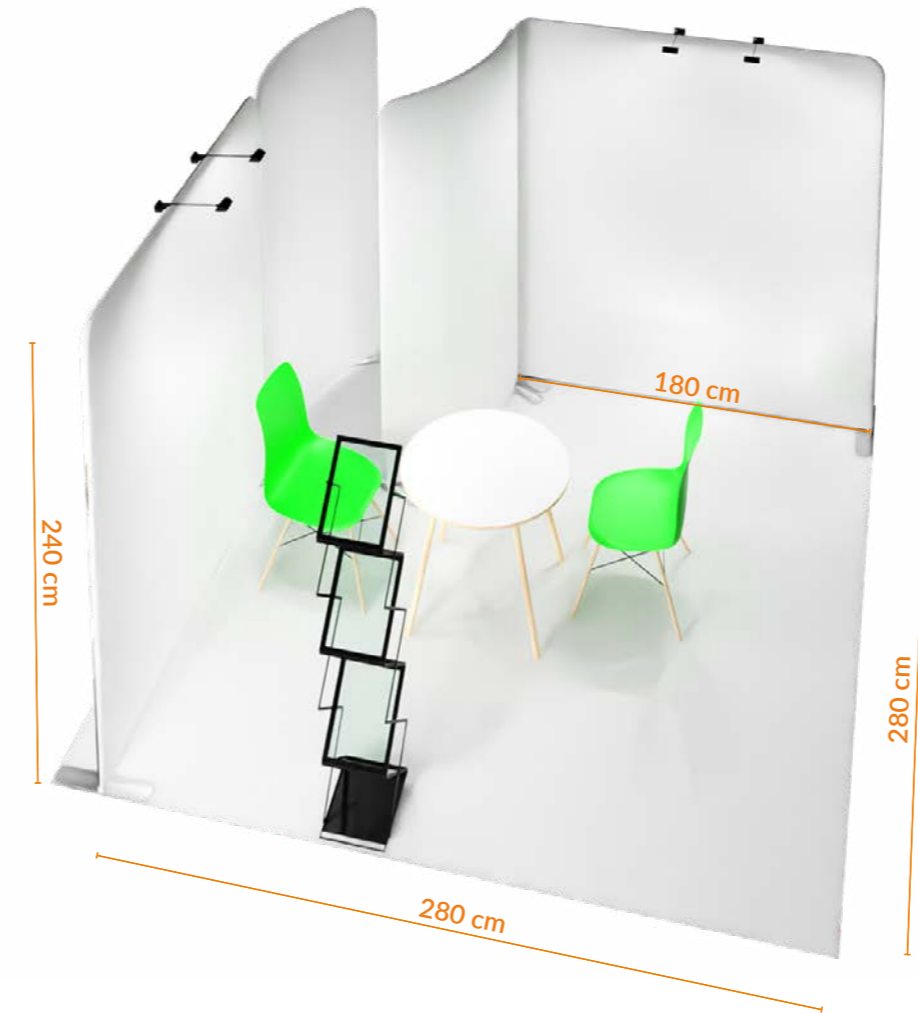

-  **Wall layout SEMI ISLAND**
-  **Easy Transportation**
-  **Quick installation**

The 3x3 SEMI ISLAND B exhibition stand is made of a light aluminium structure, which is assembled with strong magnets. Comes with carpeting with the print of your choice. The stand is open on two sides and has a small back section. An excellent choice for small exhibition space. The structure is foldable and fits in the dedicated bags for much easier transport. Comes with all elements required for assembly and an instruction manual.

Information

Exhibition Stand [cm]
300x300x240
Total weight [kg]
51



Details
Package dimensions [cm]
4x[25x103x13] + 2x[105x25x25]

Non-equipped stand

| | |
|-----------------------------------|------|
| modular wall | 4pcs |
| interchangeable fabric with print | 4pcs |
| fitted carpet with print | 1pcs |

2 280 EUR

Additional equipment

Additional equipment

Ask your advisor about tables, counters, chairs, flyer displays, extension cords or additional lighting. We also offer a range of accessories - advertising cups, flags, rollups, stands, displays and much more.

Write to us - we are at your service!

EXHIBITION STAND

Internal LED backlighting



Interchangeable large-format printed images

Custom-printed Carpet

3x3 L-SHAPE ZEN

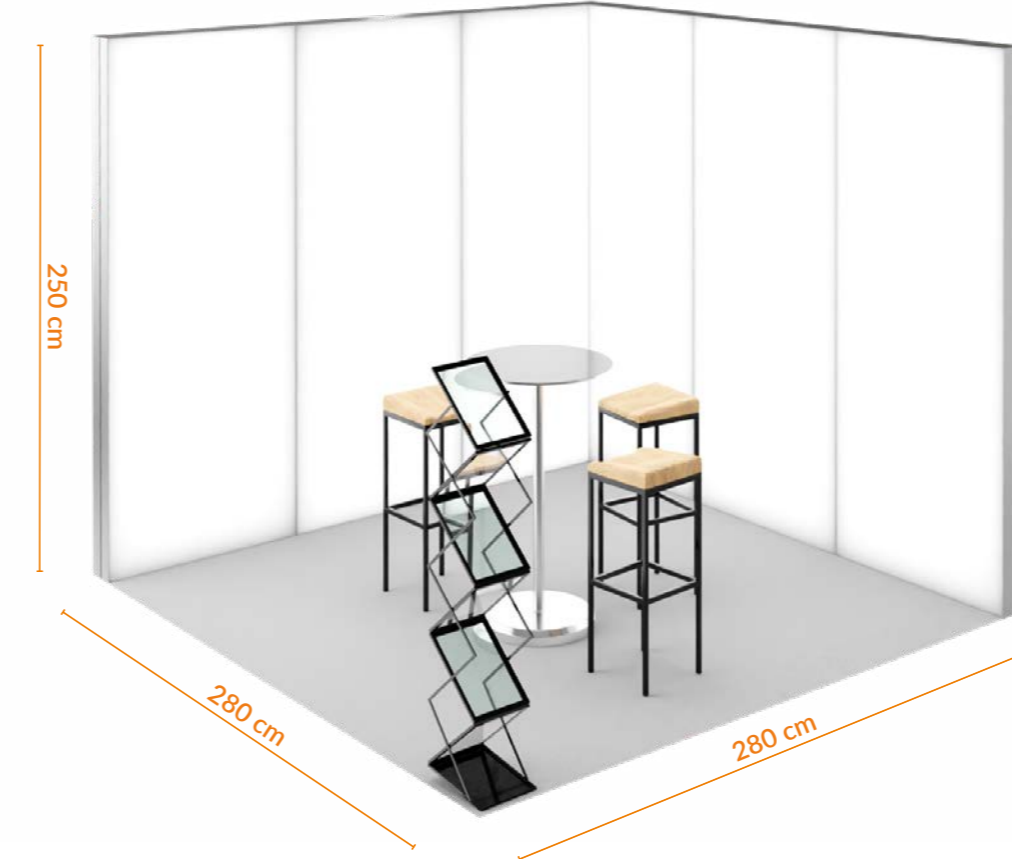

- Wall layout L-SHAPE
- Quick installation

The 3x3 L-SHAPE ZEN exhibition stand is made of aluminium profiles for DIY assembly and carpeting with the print of your choice. The stand is open on two sides and has big backlit walls. It is very popular for smaller exhibition space. Comes with all elements required for assembly and an instruction manual.



Information

Exhibition Stand [cm]
300x300x250
Total weight [kg]
104



Details
Package dimensions [cm]
6x[255x20x15] + 2x[105x25x25]



Non-equipped stand

| | |
|-----------------------------------|------|
| modular wall | 6pcs |
| interchangeable fabric with print | 2pcs |
| fitted carpet with print | 1pcs |

2 287 EUR



Additional equipment

Ask your advisor about tables, counters, chairs, flyer displays, extension cords or additional lighting. We also offer a range of accessories - advertising cups, flags, rollups, stands, displays and much more.

Write to us - we are at your service!

EXHIBITION STAND

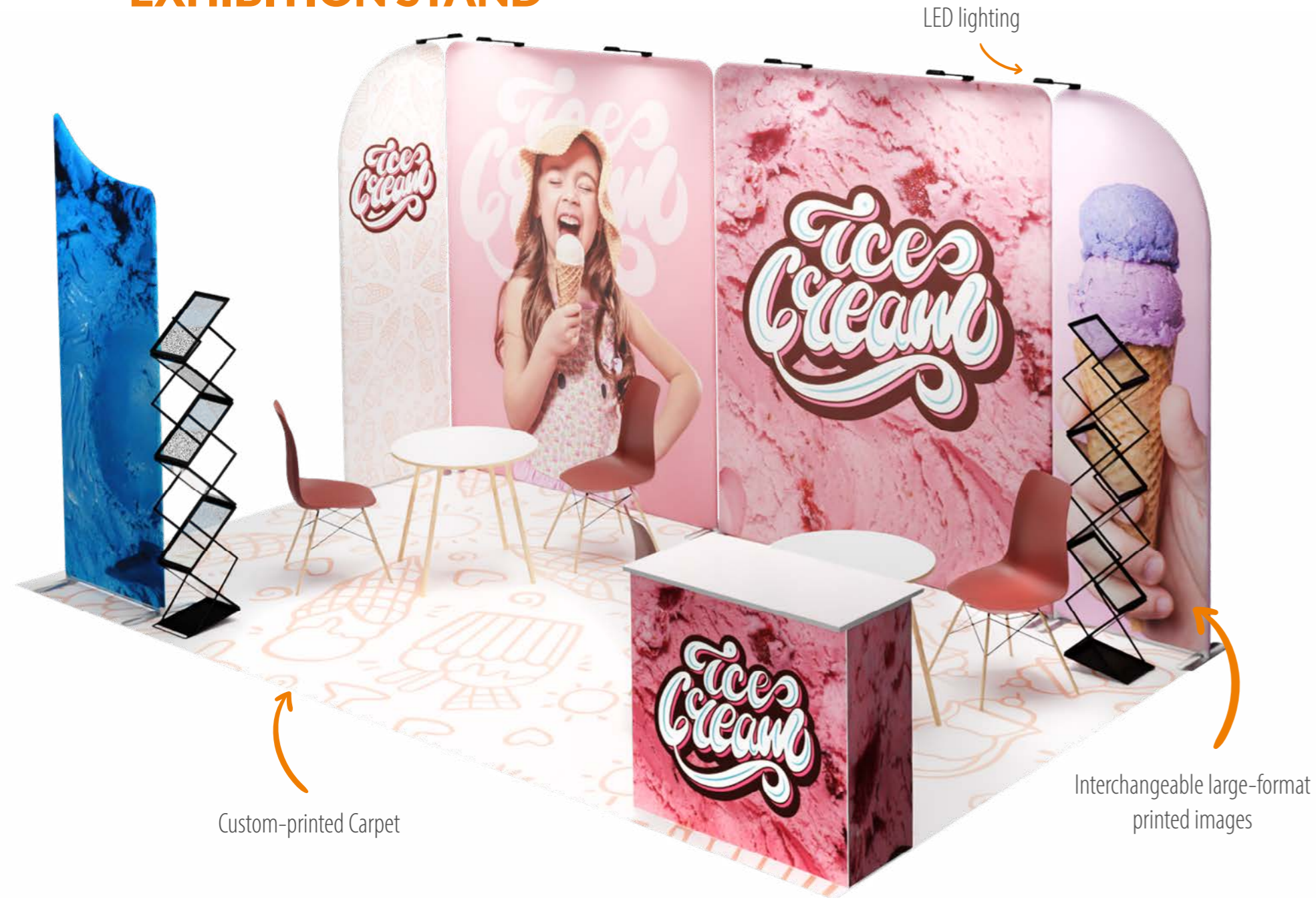

Custom-printed Carpet

LED lighting

Interchangeable large-format printed images

3x5 SEMI ISLAND

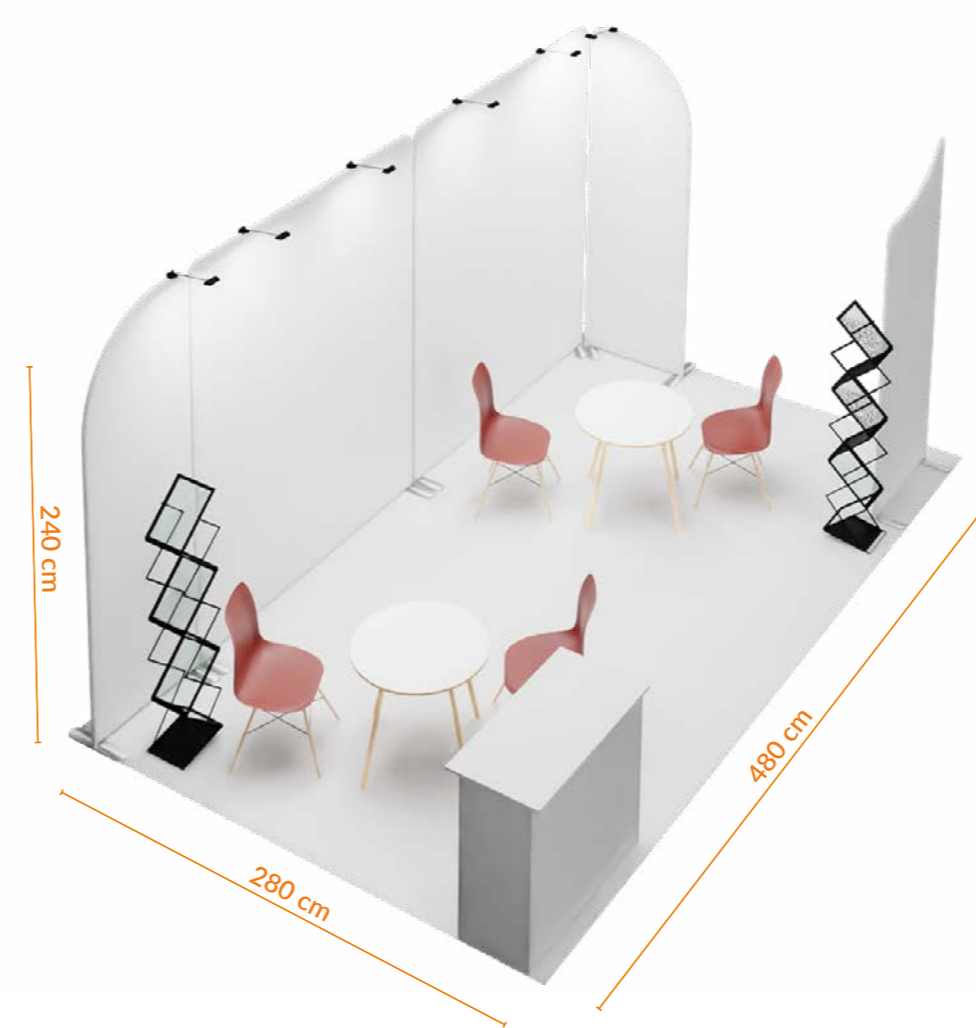

-  **Wall layout SEMI ISLAND**
-  **Easy Transportation**
-  **Quick installation**

The 3x5 SEMI ISLAND exhibition stand is made of a light aluminium structure, which is assembled with strong magnets. Comes with carpeting with the print of your choice. The additional freestanding irregularly shaped partition can be set up anywhere. The structure is foldable and fits in the dedicated bags for much easier transport. Comes with all elements required for assembly and an instruction manual.



Information

Exhibition Stand [cm]
300x500x240
Total weight [kg]
60



Details
Package dimensions [cm]
5x[25x103x13] + 3x[105x25x25]

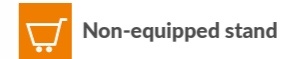

Non-equipped stand

| | |
|-----------------------------------|------|
| modular wall | 6pcs |
| interchangeable fabric with print | 6pcs |
| fitted carpet with print | 1pcs |

 **2 608 EUR**



Additional equipment

Ask your advisor about tables, counters, chairs, flyer displays, extension cords or additional lighting. We also offer a range of accessories - advertising cups, flags, rollups, stands, displays and much more.

Write to us - we are at your service!

EXHIBITION STAND

Interchangeable large-format printed images

LED lighting



Custom-printed Carpet

3x5 SEMI ISLAND A

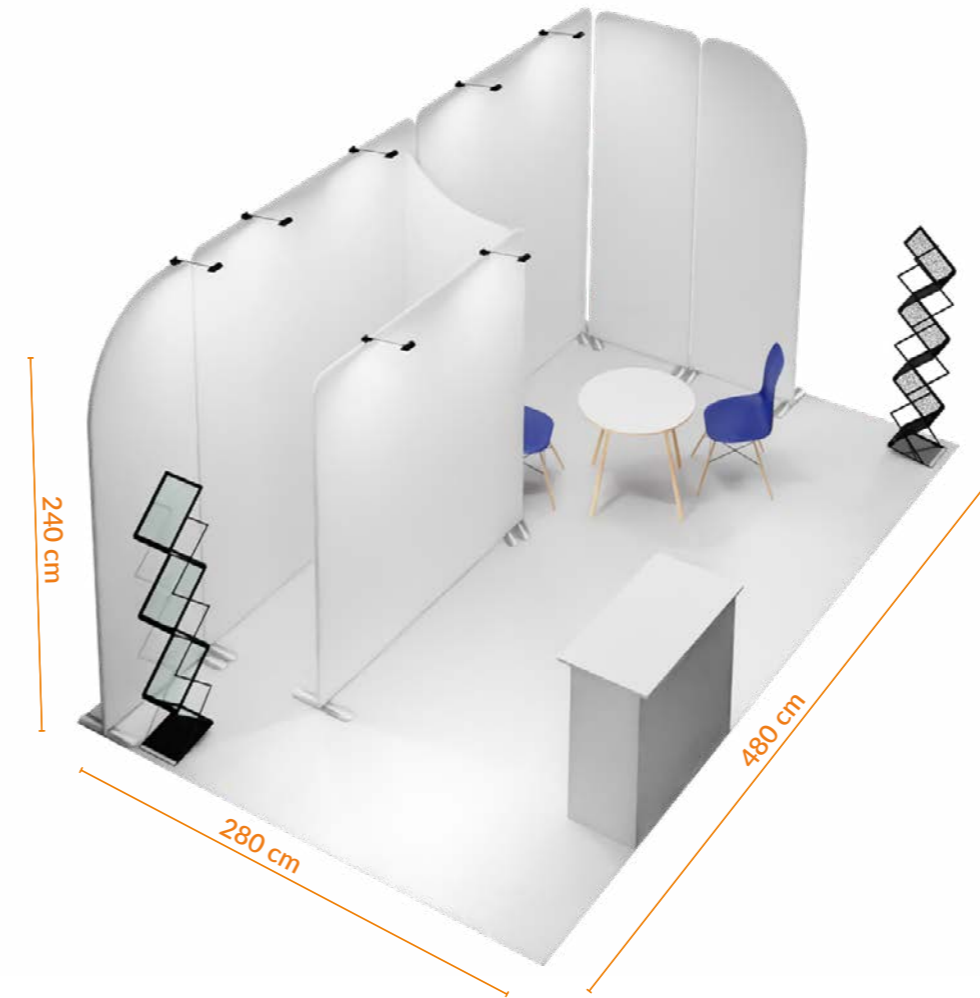

-  **Wall layout SEMI ISLAND**
-  **Easy Transportation**
-  **Quick installation**

The 3x5 SEMI ISLAND A exhibition stand is made of a light aluminium structure, which is assembled with strong magnets. Comes with carpeting with the print of your choice. Compared to the basic version, it has a bigger back section and is shaped like an L. The structure is foldable and fits in the dedicated bags for much easier transport. Comes with all elements required for assembly and an instruction manual.

Information

Exhibition Stand [cm]
300x500x240
Total weight [kg]
75

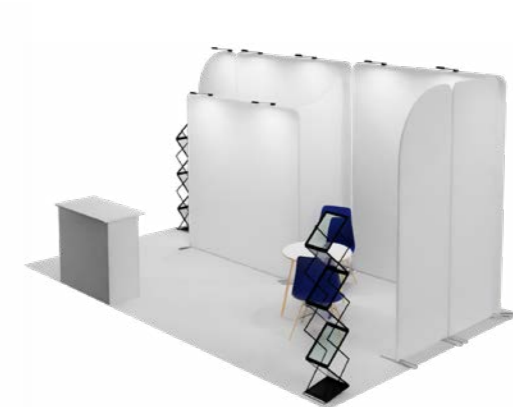

Details
Package dimensions [cm]
7x[25x103x13] + 3x[105x25x25]

Non-equipped stand

| | |
|-----------------------------------|------|
| modular wall | 7pcs |
| interchangeable fabric with print | 7pcs |
| fitted carpet with print | 1pcs |

3 634 EUR

Additional equipment

Ask your advisor about tables, counters, chairs, flyer displays, extension cords or additional lighting. We also offer a range of accessories - advertising cups, flags, rollups, stands, displays and much more.

Write to us - we are at your service!

EXHIBITION STAND

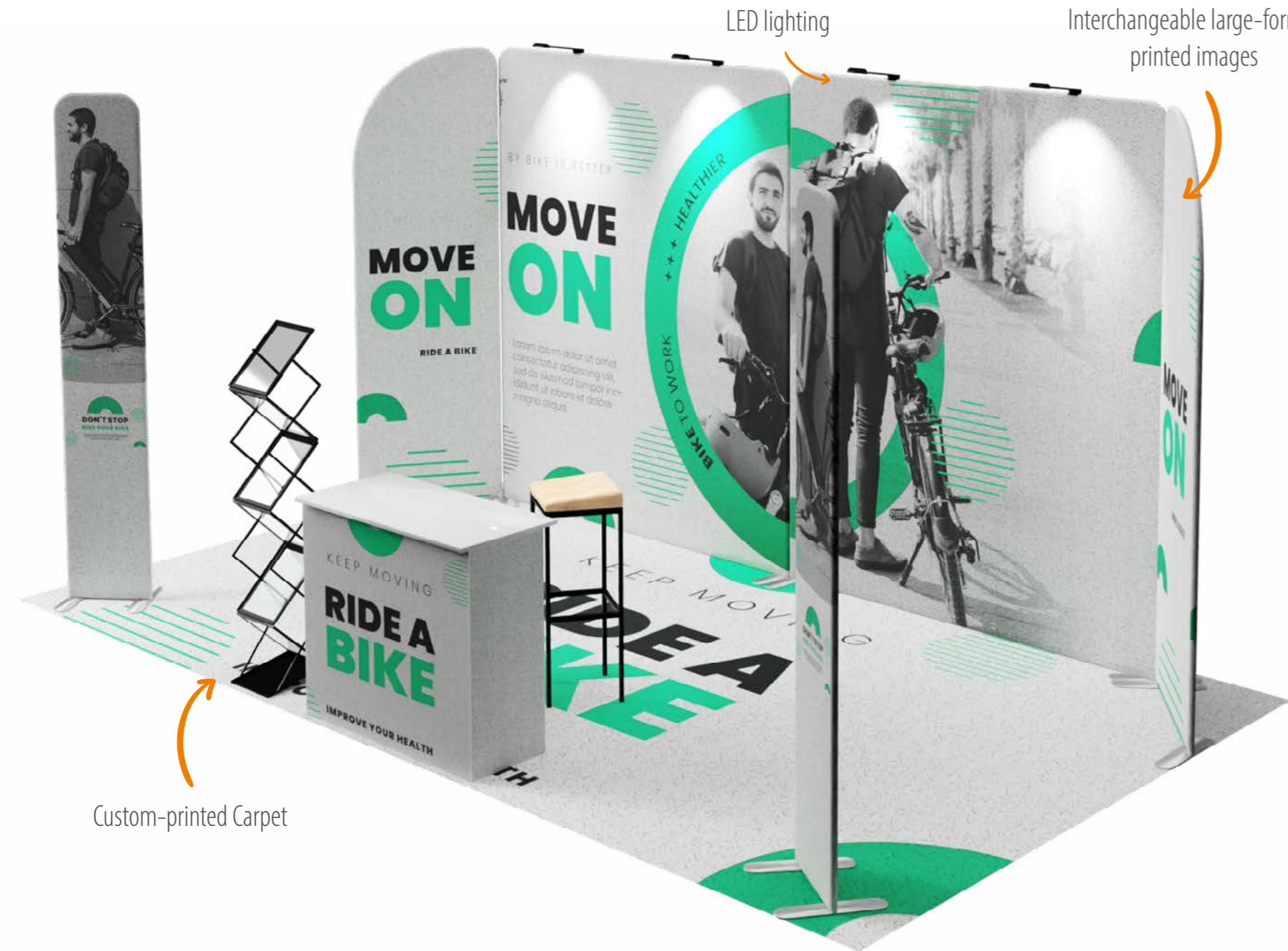

3x5 SEMI ISLAND B

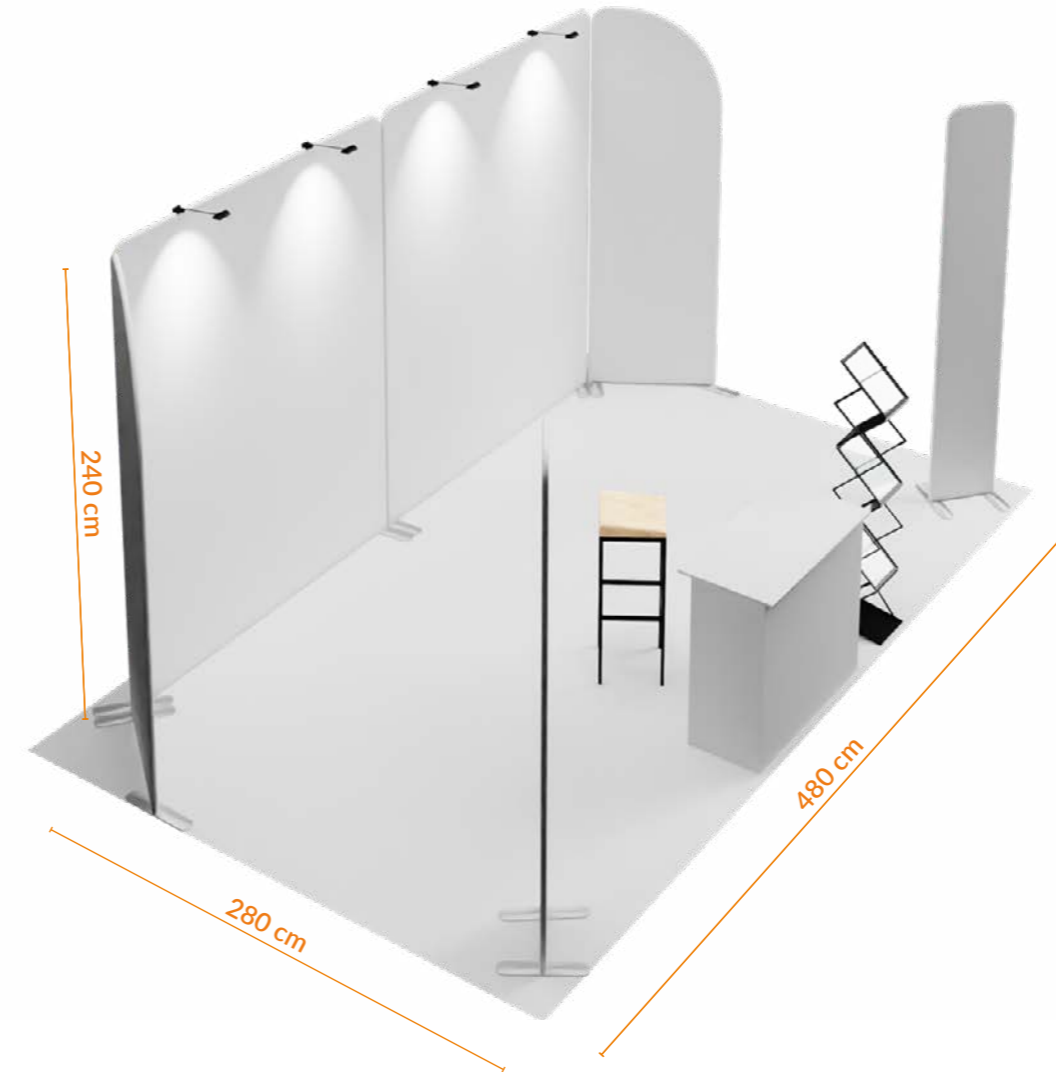

-  **Wall layout SEMI ISLAND**
-  **Easy Transportation**
-  **Quick installation**

The 3x5 SEMI ISLAND B exhibition stand is made of a light aluminium structure, which is assembled with strong magnets. Comes with carpeting with the print of your choice. The stand is open on three sides, covers almost 15 m2, and is arranged in a convenient way, which makes it easy to plan out equipment locations. The structure is foldable and fits in the dedicated bags for much easier transport. Comes with all elements required for assembly and an instruction manual.

Information

Exhibition Stand [cm]
300x500x240
Total weight [kg]
75

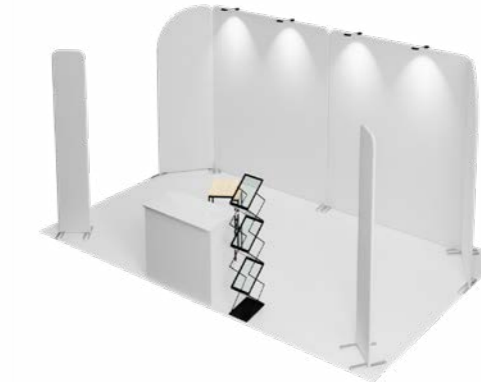

Details
Package dimensions [cm]
6x[25x103x13] + 3x[105x25x25]

Non-equipped stand

| | |
|-----------------------------------|------|
| modular wall | 6pcs |
| interchangeable fabric with print | 6pcs |
| fitted carpet with print | 1pcs |

2 937 EUR

Additional equipment

Ask your advisor about tables, counters, chairs, flyer displays, extension cords or additional lighting. We also offer a range of accessories - advertising cups, flags, rollups, stands, displays and much more.

Write to us - we are at your service!

EXHIBITION STAND

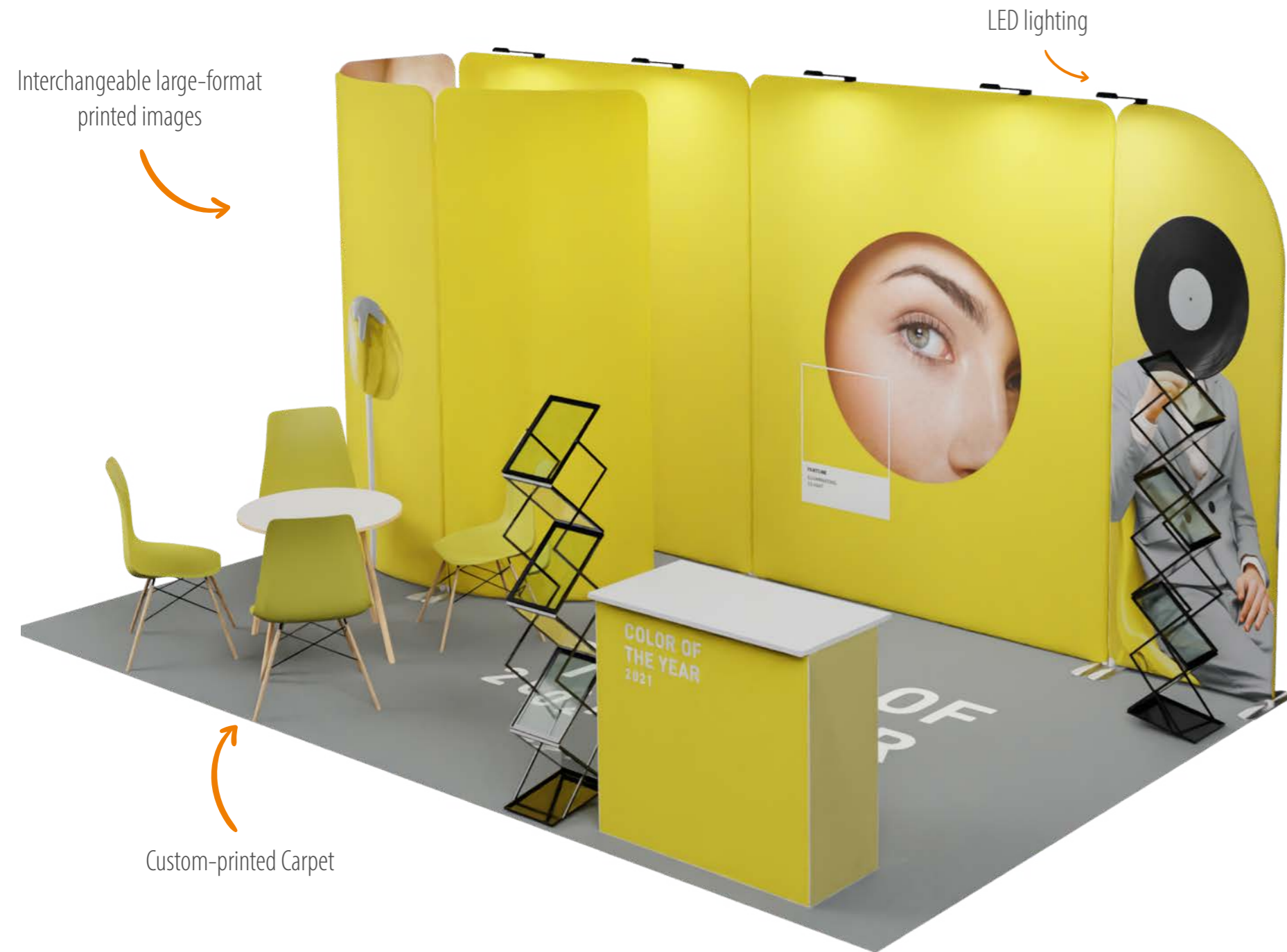

3x5 SEMI ISLAND C

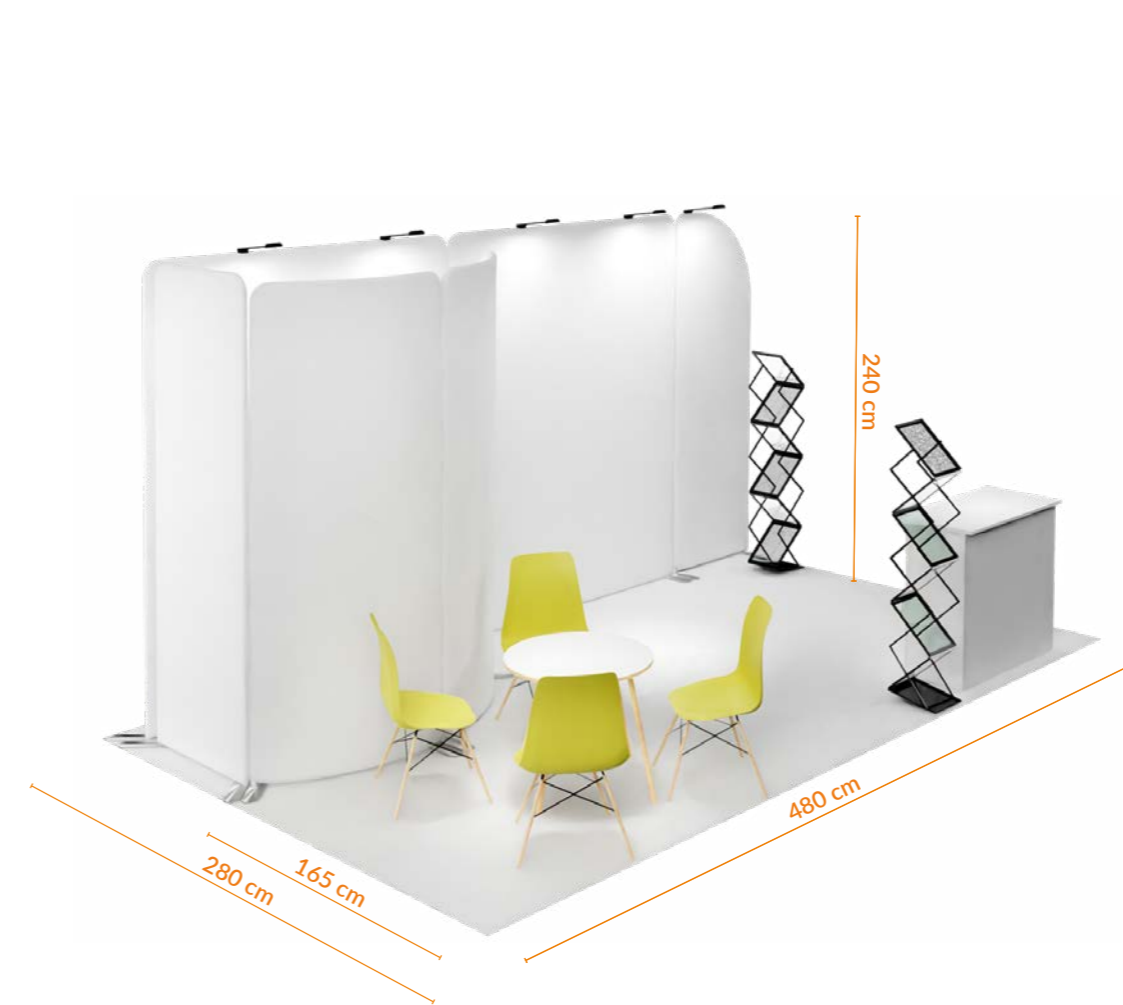

Information

Exhibition Stand [cm]
300x500x240
Total weight [kg]
75



Details
Package dimensions [cm]
6x[25x103x13] + 3x[105x25x25]



Non-equipped stand

| | |
|-----------------------------------|------|
| modular wall | 6pcs |
| interchangeable fabric with print | 6pcs |
| fitted carpet with print | 1pcs |

3 109 EUR



Additional equipment

Ask your advisor about tables, counters, chairs, flyer displays, extension cords or additional lighting. We also offer a range of accessories - advertising cups, flags, rollups, stands, displays and much more.

Write to us - we are at your service!

- Wall layout SEMI ISLAND
- Easy Transportation
- Quick installation

The 3x5 SEMI ISLAND C exhibition stand is made of a light aluminium structure, which is assembled with strong magnets. Comes with carpeting with the print of your choice. The stand is open on three sides and has an irregular and interestingly arranged back section. The structure is foldable and fits in the dedicated bags for much easier transport. Comes with all elements required for assembly and an instruction manual.

EXHIBITION STAND



3x5 L-SHAPE ZEN

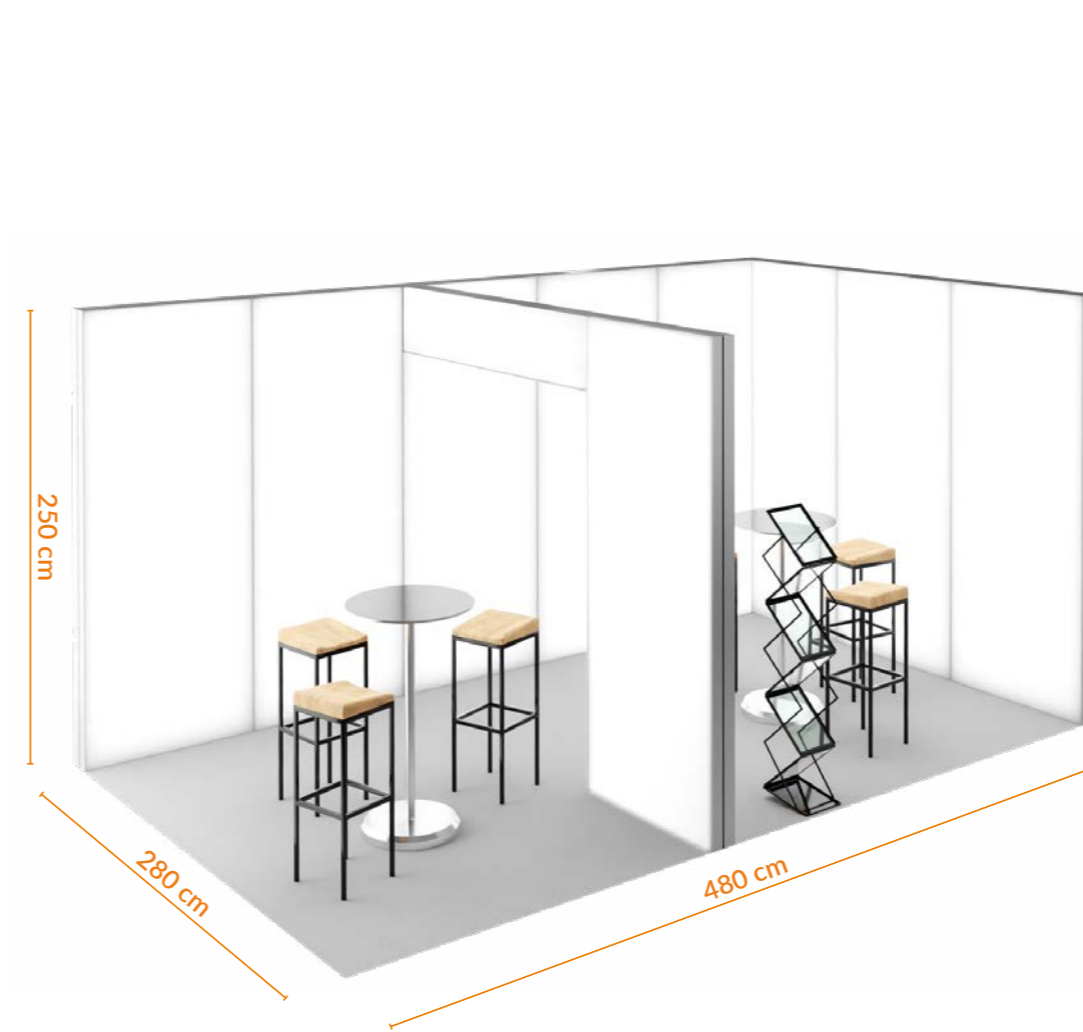

Information

Exhibition Stand [cm]
300x500x250
Total weight [kg]
280



Details

Package dimensions [cm]

9x[255x20x15] + 3x[105x25x25]

Non-equipped stand

| | |
|-----------------------------------|--------|
| modular wall+frieze | 9+2pcs |
| interchangeable fabric with print | 6pcs |
| fitted carpet with print | 1pcs |

6 191 EUR

Additional equipment

Additional equipment

Ask your advisor about tables, counters, chairs, flyer displays, extension cords or additional lighting. We also offer a range of accessories - advertising cups, flags, rollups, stands, displays and much more.

Write to us - we are at your service!

Wall layout L-SHAPE

Quick installation

The 3x5 L-SHAPE ZEN exhibition stand is made of aluminium profiles for DIY assembly and carpeting with the print of your choice. The stand is open on two sides and has an attractive partition in the middle to split the space in half. Comes with all elements required for assembly and an instruction manual.

EXHIBITION STAND



4x4 ISLAND

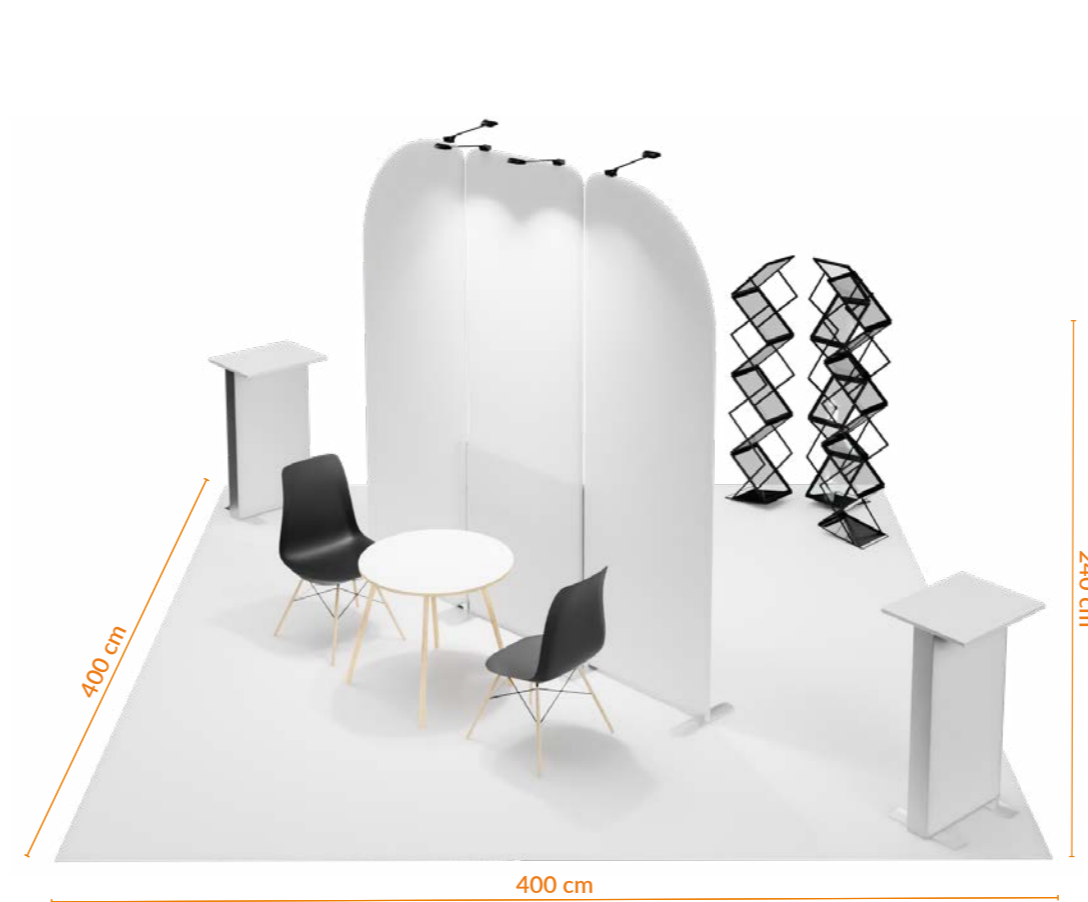

Information

Exhibition Stand [cm]
400x400x240
Total weight [kg]
44

Details

Package dimensions [cm]
3x[25x103x13] + 3x[105x25x25]



Non-equipped stand

| | |
|-----------------------------------|------|
| modular wall | 3pcs |
| interchangeable fabric with print | 3pcs |
| fitted carpet with print | 1pcs |

1 349 EUR



Additional equipment

Ask your advisor about tables, counters, chairs, flyer displays, extension cords or additional lighting. We also offer a range of accessories - advertising cups, flags, rollups, stands, displays and much more.

Write to us - we are at your service!

- Wall layout ISLAND
- Easy Transportation
- Quick installation

The 4x4 ISLAND exhibition stand is made of a light aluminium structure, which is assembled with strong magnets. Comes with carpeting with the print of your choice. An island-type stand with two allocated conversation zones. The perfect choice for a shopping centre or exhibition island. The structure is foldable and fits in the dedicated bags for much easier transport. Comes with all elements required for assembly and an instruction manual.

EXHIBITION STAND

Interchangeable large-format printed images

LED lighting



Custom-printed Carpet

The counter is also available with backlight – ask your consultant

Counter also available with illumination - ask your consultant
The images in the catalogue are for illustrative purposes only and the appearance of individual accessories may vary throughout the year, depending on availability.

4x4 L-SHAPE

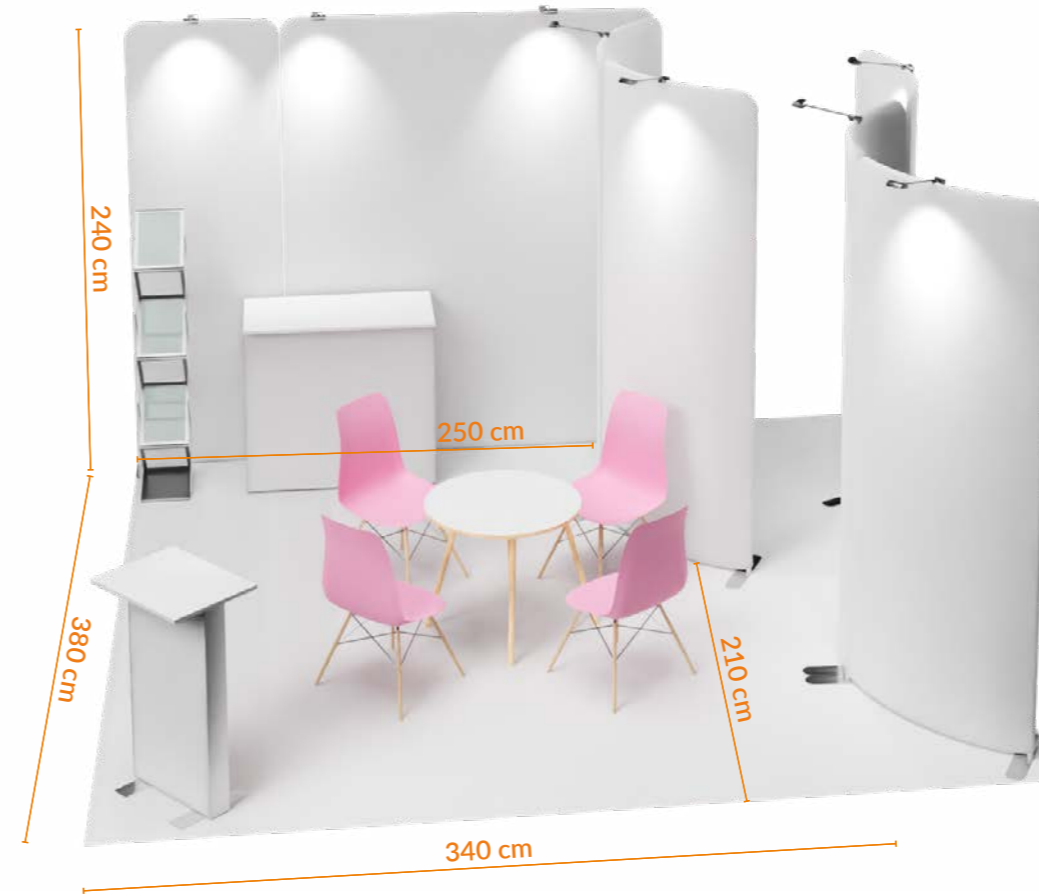

- Wall layout L-SHAPE
- Easy Transportation
- Quick installation

The 4x4 L-SHAPE exhibition stand is made of a light aluminium structure, which is assembled with strong magnets. Comes with carpeting with the print of your choice. The backlit partitions are designed to serve as visual attractions and a semi-circular back section and to allow for convenient equipment arrangement. The structure is foldable and fits in the dedicated bags for much easier transport. Comes with all elements required for assembly and an instruction manual.



Information

Exhibition Stand [cm]
400x400x240
Total weight [kg]
80



Details
Package dimensions [cm]
7x[25x103x13] + 3x[105x25x25]



Non-equipped stand

| | |
|-----------------------------------|------|
| modular wall | 7pcs |
| interchangeable fabric with print | 7pcs |
| fitted carpet with print | 1pcs |

3 015 EUR



Additional equipment

Ask your advisor about tables, counters, chairs, flyer displays, extension cords or additional lighting.
We also offer a range of accessories - advertising cups, flags, rollups, stands, displays and much more.

Write to us - we are at your service!



Application:

- Islands in the galleries
- Business conferences
- Promotions in supermarkets
- Trade fair stands

EXHIBITION STAND



5x5 ISLAND ZEN

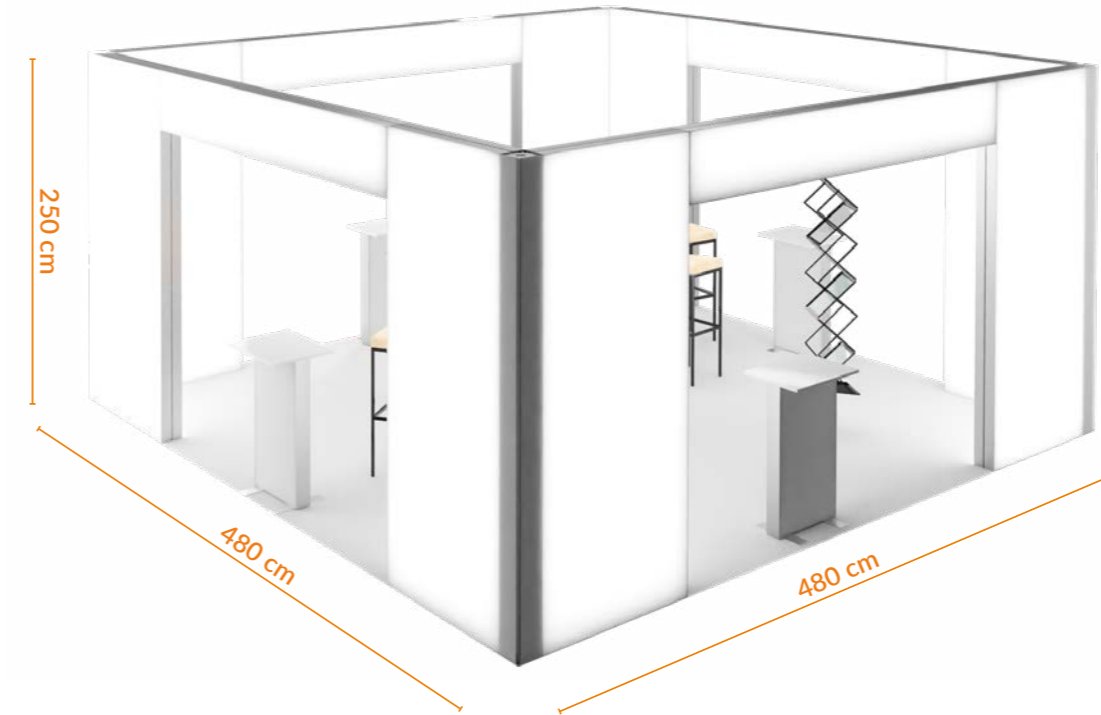

- Wall layout ISLAND
- Quick installation

The 5x5 ISLAND ZEN exhibition stand is made of aluminium profiles for DIY assembly and carpeting with the print of your choice. This is a big and spacious stand with walls of an attractive shape allowing for plenty of creativity in designing graphics. Comes with all elements required for assembly and an instruction manual.

Information

Exhibition Stand [cm]
500x500x250
Total weight [kg]
350

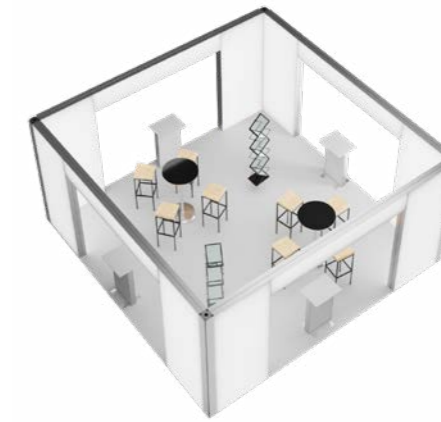

Details
Package dimensions [cm]
8x[255x20x15] + 5x[105x25x25]
+ 2x[290 x20x15]

Non-equipped stand

| | |
|-----------------------------------|--------|
| modular wall+frieze | 8+8pcs |
| interchangeable fabric with print | 24pcs |
| fitted carpet with print | 1pcs |

6 665 EUR

Additional equipment

Ask your advisor about tables, counters, chairs, flyer displays, extension cords or additional lighting. We also offer a range of accessories - advertising cups, flags, rollups, stands, displays and much more.

Write to us - we are at your service!

EXHIBITION STAND



5x5 ISLAND ZEN A

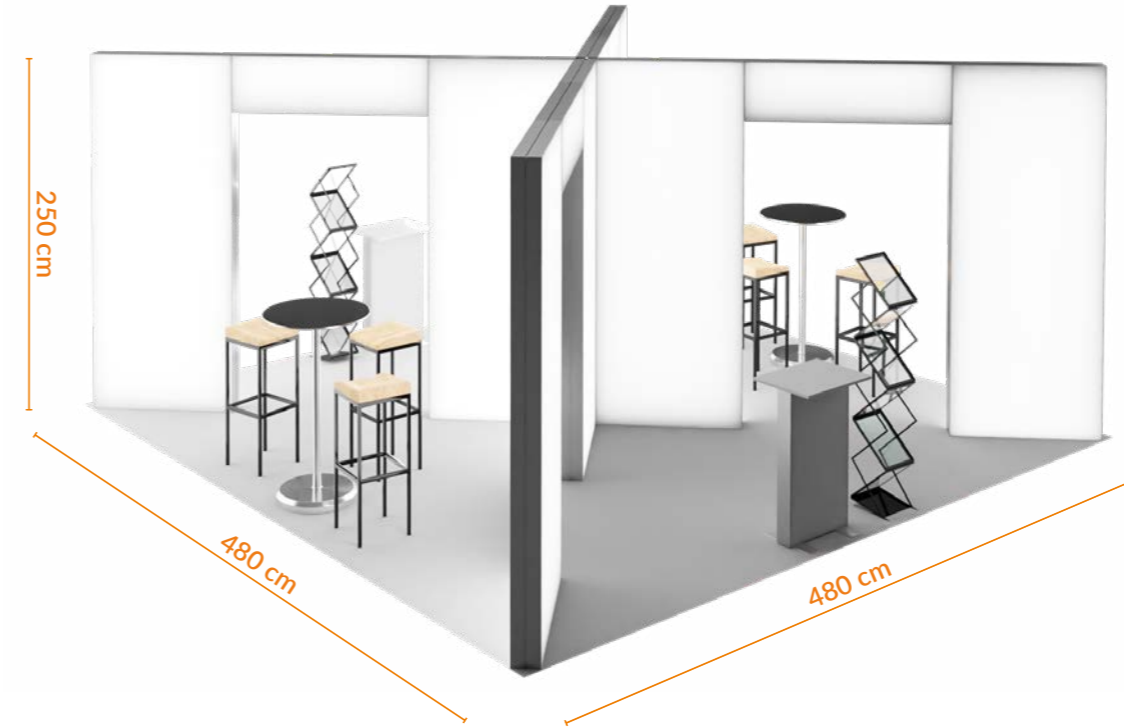

Information

Exhibition Stand [cm]
500x500x250
Total weight [kg]
310



Details
Package dimensions [cm]
8x[255x20x15] + 5x[105x25x25]

Non-equipped stand

| | |
|-----------------------------------|--------|
| modular wall+frieze | 8+8pcs |
| interchangeable fabric with print | 24pcs |
| fitted carpet with print | 1pcs |

6 402 EUR

Additional equipment

Ask your advisor about tables, counters, chairs, flyer displays, extension cords or additional lighting. We also offer a range of accessories - advertising cups, flags, rollups, stands, displays and much more.

Write to us - we are at your service!

- Wall layout ISLAND
- Quick installation

The 5x5 ISLAND ZEN A exhibition stand is made of aluminium profiles for DIY assembly and carpeting with the print of your choice. This is a big and spacious stand. Contrary to the basic version, the partitions are set up diagonally, which divides the space in a natural manner and creates four separate conversation spaces. Comes with all elements required for assembly and an instruction manual.

EXHIBITION STAND



6x4 L-SHAPE

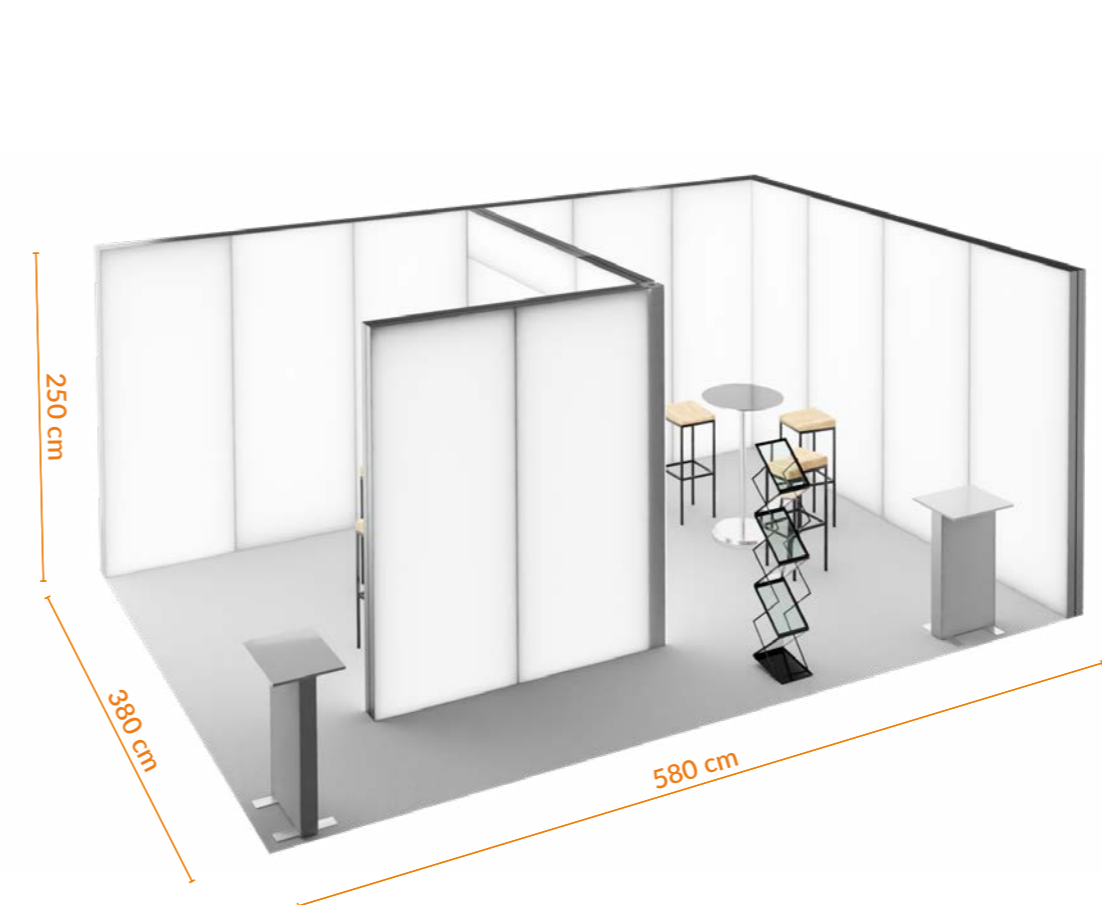

Information

Exhibition Stand [cm]
600x400x250
Total weight [kg]
400



Details
Package dimensions [cm]
13x[255x20x15] + 4x[105x25x25]

Non-equipped stand

| | |
|-----------------------------------|---------|
| modular wall+frieze | 13+1pcs |
| interchangeable fabric with print | 9 pcs |
| fitted carpet with print | 1pcs |

8 235 EUR

Additional equipment

Ask your advisor about tables, counters, chairs, flyer displays, extension cords or additional lighting. We also offer a range of accessories - advertising cups, flags, rollups, stands, displays and much more.

Write to us - we are at your service!

- Wall layout L-SHAPE
- Quick installation

The 6x4 L-SHAPE exhibition stand is made of aluminium profiles for DIY assembly and carpeting with the print of your choice. This is the biggest stand in our offer of ready to use solutions. 22 m2 of space split with an irregular partition to form several separate sections for conversations and plenty of graphics display space. Comes with all elements required for assembly and an instruction manual.

Counter also available with illumination - ask your consultant
The images in the catalogue are for illustrative purposes only and the appearance of individual accessories may vary throughout the year, depending on availability.



Application:



Promotions in supermarkets
Trade fair stands
Shopping malls

FURNISHINGS

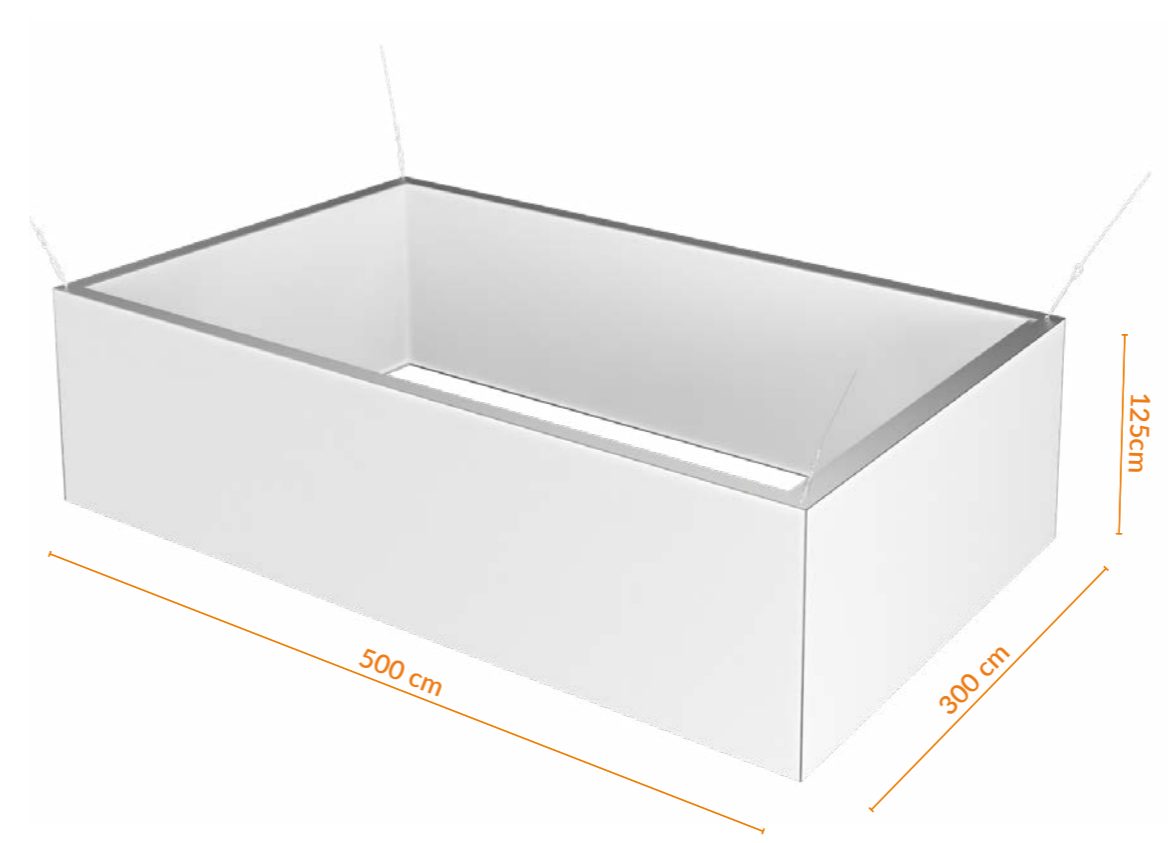

3x5 ZEN



-  **Shape: TYPE "O"**
-  **Quick installation**

The textile 3x5 ZEN suspension system complements our offer for exhibitors and organisers of events, galas, and conferences. It makes for easier orientation of guests at events. The Zen system is made of high quality aluminium alloys. The systems are light, which makes them easy to suspend from load bearing structures.

 **Information**

System dimensions from visualization [cm]
300x500x125cm
Total weight [kg]
32,1kg

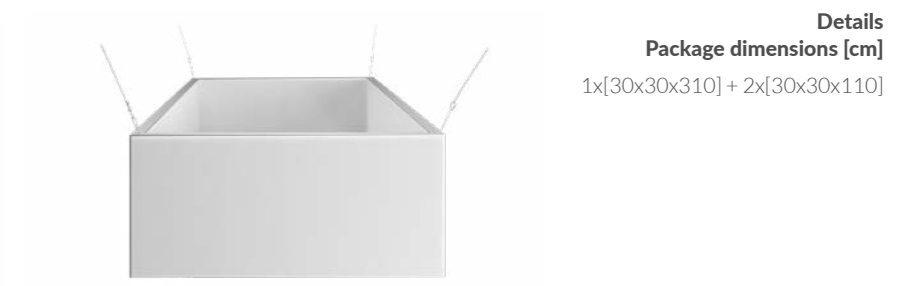

Details
Package dimensions [cm]
1x[30x30x310] + 2x[30x30x110]

 **Other sizes available**

| Dimensions | Price |
|-------------|-----------|
| 200x200x100 | 800 EUR |
| 300x300x125 | 1 221 EUR |
| 200x400x150 | 1 421 EUR |
| 300x600x150 | 1 909 EUR |
| 400x400x150 | 1 700 EUR |
| 600x600x200 | 2 688 EUR |

 **Set price**

| | |
|-----------------------------------|------|
| Suspended systems | 1pcs |
| interchangeable fabric with print | 4pcs |
| fabric without print | 4pcs |
| Metal holders | 3pcs |
| Spring hooks | 3pcs |
| Lines for installation (2m each) | 3pcs |

 **1 907 EUR**

 **Additional equipment**



Need more accessories for your stall? Would you like to stand out to attract the visitors? Check out what's available in our offer. Choose from: flags, advertising cups, roll ups, countertop displays. And many more...

FURNISHINGS

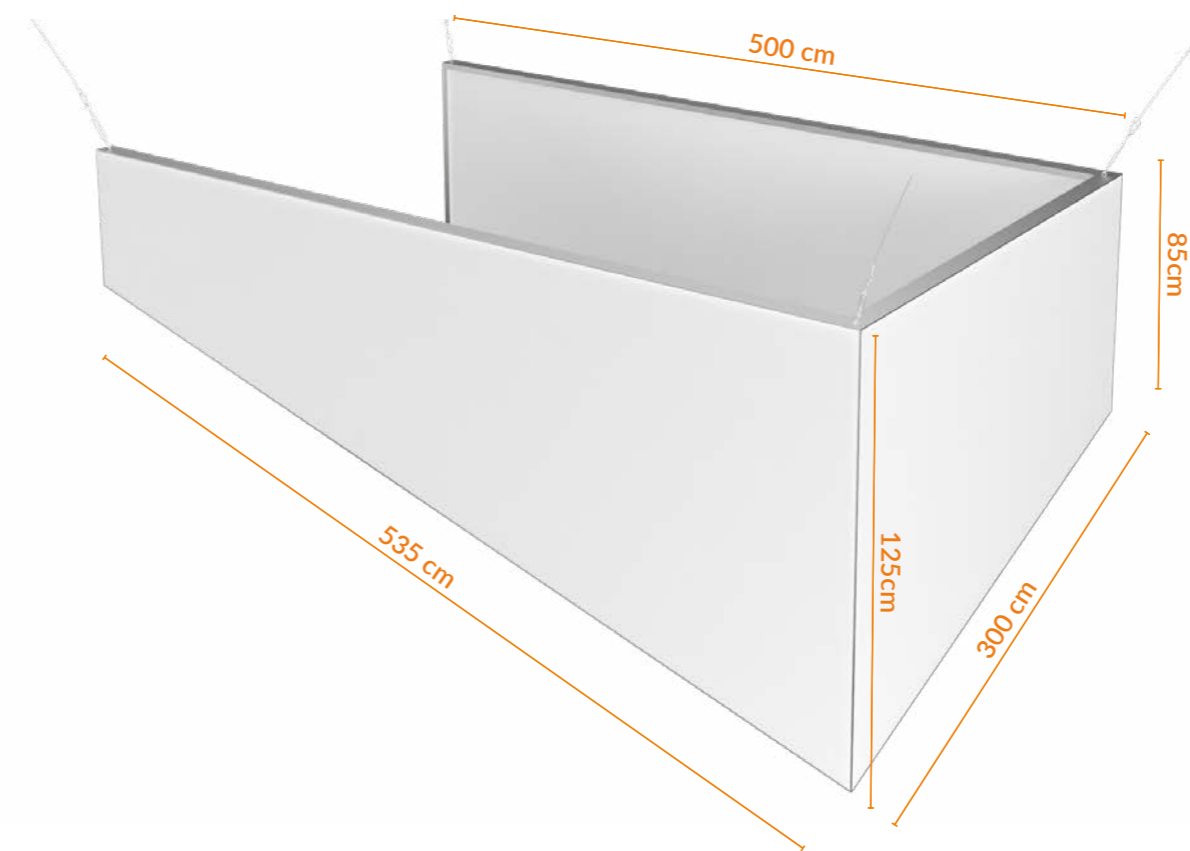

3x5 ZEN CUSTOM



-  **Shape: TYPE „CUSTOM“**
-  **Quick installation**

The textile 3x5 ZEN CUSTOM suspension system complements our offer for exhibitors and organisers of events, galas, and conferences. By choosing the CUSTOM version, you are guaranteed that the size and shape of the system will fulfil your expectations. The Zen system is made of high quality aluminium alloys. The systems are light, which makes them easy to suspend from load bearing structures.

| | |
|---|---|
|  Information | System dimensions from visualization [cm] 300x500x125cm |
| | Total weight [kg] 35 |

| | |
|--|---|
|  Details | Package dimensions [cm] 1x[30x30x310] + 2x[30x30x110] |
|--|---|

| | |
|--|------|
|  Set price | |
| Suspended systems | 1pcs |
| interchangeable fabric with print | 3pcs |
| fabric without print | 3pcs |
| Metal holders | 4pcs |
| Spring hooks | 4pcs |
| Lines for installation (2m each) | 4pcs |

 **Ask your advisor**

The visualised model is priced at 2 209 EUR

 **Additional equipment**

Need more accessories for your stall? Would you like to stand out to attract the visitors? Check out what's available in our offer. Choose from: flags, advertising cups, roll ups, countertop displays. And many more...



Application:

Promotions in supermarkets
Trade fair stands
Shopping malls

\$ Pricing

| Type of stand | Stand type | Non-equipped stand |
|---------------|---|--------------------|
| PROMO STAND | 1x1 SEMI ISLAND  | 479,77 EUR |
| PROMO STAND | 1x2 SEMI ISLAND  | 959,53 EUR |
| PROMO STAND | 1x3 SEMI ISLAND  | 1 439,30 EUR |
| PROMO STAND | 1x4 SEMI ISLAND  | 1 907,44 EUR |
| PROMO STAND | 2x1 L-SHAPE ZEN  | 1 435,12 EUR |
| PROMO STAND | 2 x 2 L-SHAPE  | 1 081,40 EUR |
| PROMO STAND | 2x2 SEMI ISLAND  | 767,44 EUR |

| Type of stand | Stand type | Non-equipped stand |
|------------------|---|--------------------|
| PROMO STAND | 2x2 L-SHAPE ZEN  | 1 919,07 EUR |
| PROMO STAND | 3x1 U-SHAPE ZEN  | 2 797,44 EUR |
| EXHIBITION STAND | 3x2 L-SHAPE  | 1 753,72 EUR |
| EXHIBITION STAND | 3x2 L-SHAPE A  | 2 000,93 EUR |
| EXHIBITION STAND | 3x2 U-SHAPE A  | 4 665,81 EUR |
| PROMO STAND | 3x2 L-SHAPE ZEN  | 2 403,02 EUR |
| PROMO STAND | 3x2 U-SHAPE ZEN  | 4 665,81 EUR |

 Packaging: textile bag + box

Pricing

| Type of stand | Stand type | Non-equipped stand |
|------------------|---|--------------------|
| EXHIBITION STAND | 3x3 L-SHAPE  | 1 891,16 EUR |
| EXHIBITION STAND | 3x3 SEMI ISLAND  | 1 511,63 EUR |
| EXHIBITION STAND | 3x3 SEMI ISLAND A  | 2 026,28 EUR |
| EXHIBITION STAND | 3x3 SEMI ISLAND B  | 2 279,53 EUR |
| EXHIBITION STAND | 3x3 L-SHAPE ZEN  | 2 286,51 EUR |
| EXHIBITION STAND | 3x5 SEMI ISLAND  | 2 608,14 EUR |
| EXHIBITION STAND | 3x5 SEMI ISLAND A  | 3 633,72 EUR |

| Type of stand | Stand type | Non-equipped stand |
|------------------|--|--------------------|
| EXHIBITION STAND | 3x5 SEMI ISLAND B  | 2 936,51 EUR |
| EXHIBITION STAND | 3x5 SEMI ISLAND C  | 3 109,07 EUR |
| EXHIBITION STAND | 3x5 LSHAPE ZEN  | 6 190,70 EUR |
| EXHIBITION STAND | 4x4 ISLAND  | 1 348,84 EUR |
| EXHIBITION STAND | 4x4 L-SHAPE  | 3 014,65 EUR |
| EXHIBITION STAND | 5x5 ISLAND ZEN  | 6 665,12 EUR |
| EXHIBITION STAND | 5x5 ISLAND ZEN A  | 6 402,33 EUR |

Pricing

| Type of stand | Stand type | Non-equipped stand |
|------------------|---|--------------------|
| EXHIBITION STAND | 6x4 L-SHAPE ZEN  | 8 235,35 EUR |

| Type of stand | Stand type | Non-equipped stand |
|---------------|--|--------------------|
| FURNISHINGS | 3x5 ZEN  | 1 906,98 EUR |
| FURNISHINGS | 3x5 ZEN CUSTOM  | 2 209,30 EUR |

Additional equipment

Additional equipment
 Need more accessories for your stall?
 Would you like to stand out to attract the visitors? Check out what's available in our offer.
 Choose from: flags, advertising cups, roll ups, countertop displays. And many more...

 Packaging: textile bag + box



 Packaging: textile bag + box

GERMANY:

+48 504 237 723
+ 48 510 925 461
de@laboprint.eu

AUSTRIA:

+48 504 237 723
+ 48 510 925 461
at@laboprint.eu

NORWAY:

+48 504 067 294
no@laboprint.eu

FRANCE:

+48 504 067 403
+ 48 516 041 030
fr@laboprint.eu

LUXEMBOURG:

+48 517 250 373 (DE)
+48 504 067 403 (FR)
lu@laboprint.eu

SWITZERLAND:

+48 504 237 723 (DE)
+48 510 925 461 (DE)
+48 504 067 403 (FR)
ch@laboprint.eu

SWEDEN:

+48 504 067 389
+48 504 067 29
se@laboprint.eu

FINLAND:

+48 504 067 294
+48 504 067 389
fi@laboprint.eu

BELGIUM:

+48 504 067 403 (FR)
+48 516 041 055 (NL)
be@laboprint.eu

POLAND:

+48 510 925 460
+ 48 506 742 763
pl@laboprint.eu

IRELAND:

+48 510 925 418
+48 572 698 260
irl@laboprint.eu

UNITED KINGDOM

+48 510 925 418
+48 572 698 260
en@laboprint.eu

DENMARK:

+48 504 067 294
dk@laboprint.eu

ITALY:

+48 453 071 283
it@laboprint.eu

NETHERLANDS:

+48 516 041 055
nl@laboprint.eu

www.laboprint.eu

LABO PRINT
EXPO
Best fairs way!

www.laboprint.eu